

# Timber Towers



**beactive**  
GYMS LIMITED



# Timber Towers

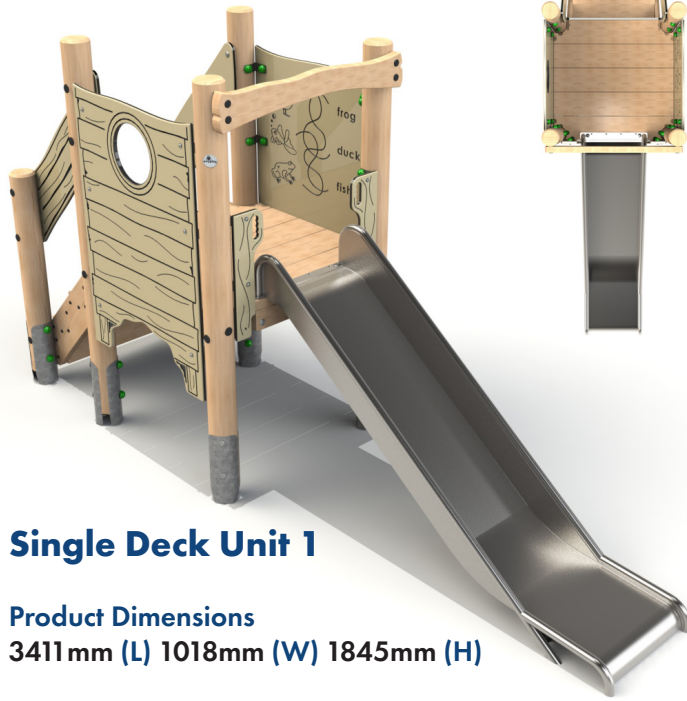

## Single Deck Unit 1

**Product Dimensions**  
3411mm (L) 1018mm (W) 1845mm (H)

**Minimum Surface Area: 23.52m<sup>2</sup>**  
6878mm (L) 4018mm (W)

**Free Fall Height: 900mm**



## Single Deck Unit 3

**Product Dimensions**  
3620mm (L) 2147mm (W) 3201mm (H)

**Minimum Surface Area: 26.44m<sup>2</sup>**  
7073mm (L) 5140mm (W)

**Free Fall Height: 1200mm**

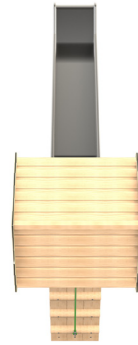

## Single Deck Unit 2

**Product Dimensions**  
4145mm (L) 1082mm (W) 3147mm (H)

**Minimum Surface Area: 25.61m<sup>2</sup>**  
7614mm (L) 4018mm (W)

**Free Fall Height: 1200mm**



## Single Deck Unit 4

**Product Dimensions**  
5550mm (L) 2094mm (W)  
2970mm (H)

**Minimum Surface Area: 32.97m<sup>2</sup>**  
8984mm (L) 5102mm (W)

**Free Fall Height: 1500mm**

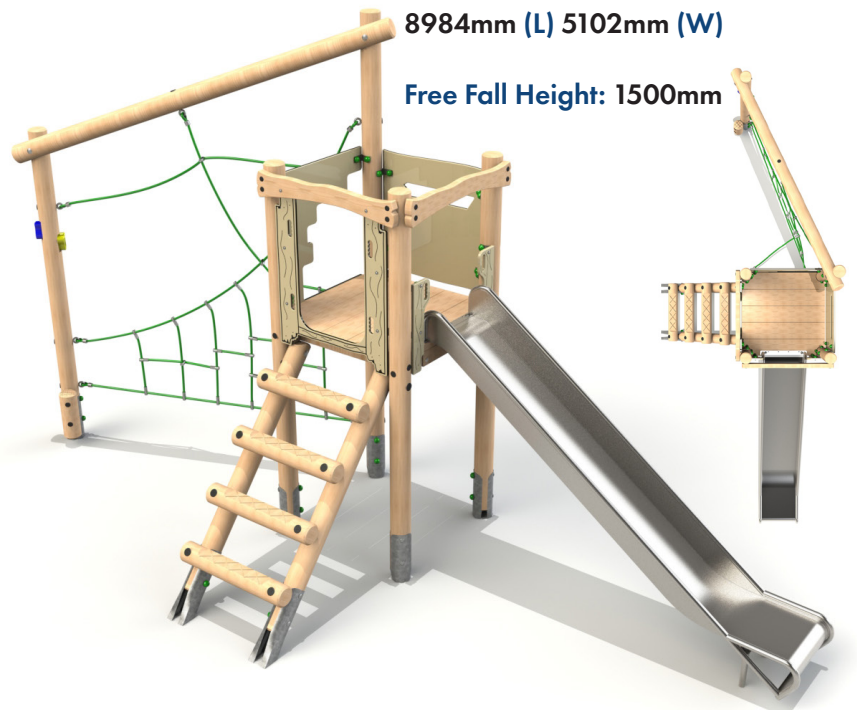

Bespoke Towers available, enquire for more information.

## Double Deck Unit 1

### Product Dimensions

5837mm (L) 2717mm (W) 2320mm (H)

Minimum Surface Area: 37.48m<sup>2</sup>

9289mm (L) 5706mm (W)

Free Fall Height: 1327mm



## Double Deck Unit 2

### Product Dimensions

5744mm (L) 4145mm (W) 2310mm (H)

Minimum Surface Area: 45.82m<sup>2</sup>

8734mm (L) 7614mm (W)

Free Fall Height: 1200mm

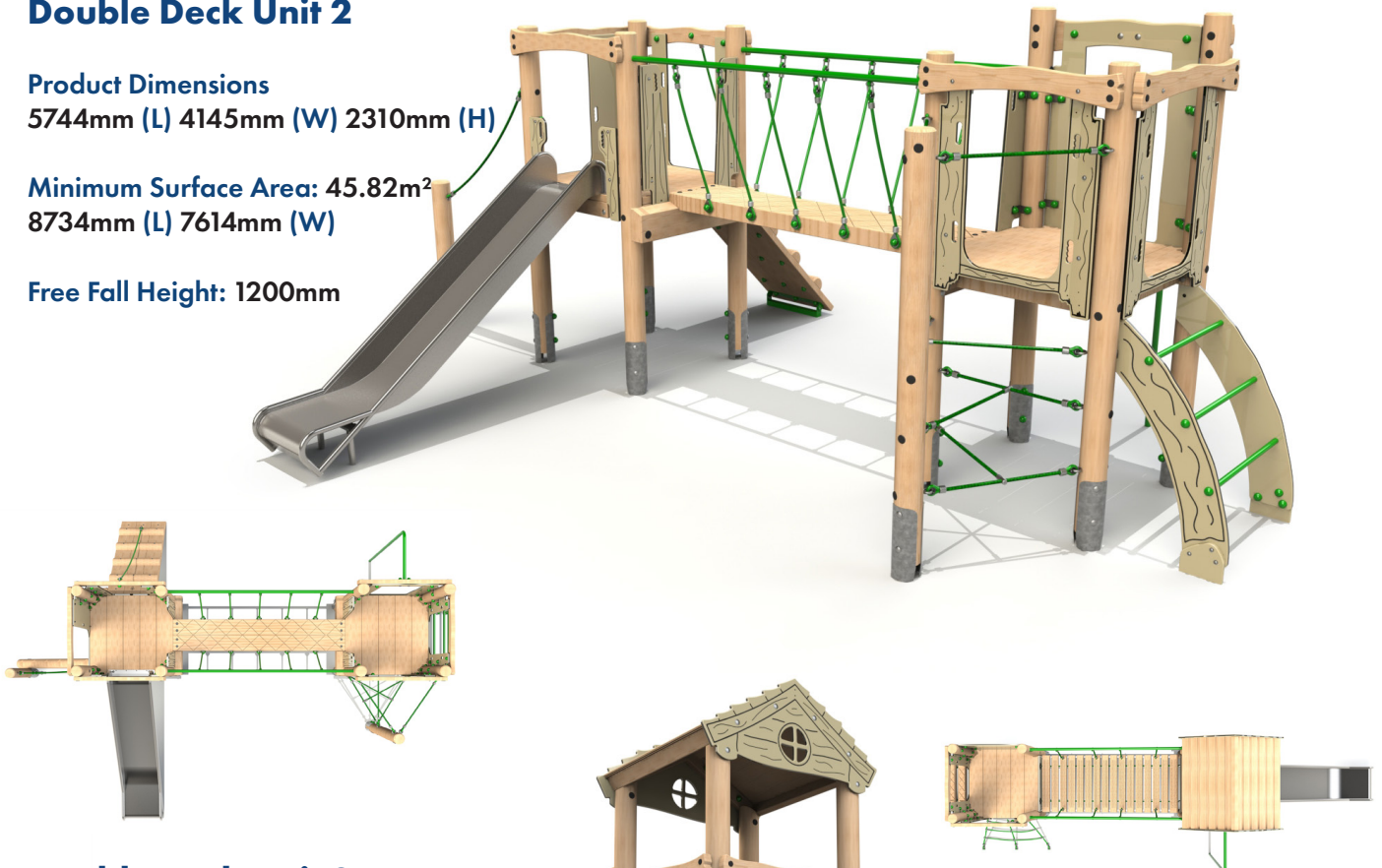

## Double Deck Unit 3

### Product Dimensions

6613mm (L) 1669mm (W) 3149mm (H)

Minimum Surface Area: 39.05m<sup>2</sup>

10082mm (L) 4607mm (W)

Free Fall Height: 1200mm



Steel feet as standard, bespoke rope colours available.



# Timber Towers

## Double Deck Unit 4

### Product Dimensions

7507mm (L) 1835mm (W) 3501mm (H)

Minimum Surface Area: 40.61m<sup>2</sup>

10976mm (L) 4791mm (W)

Free Fall Height: 1500mm

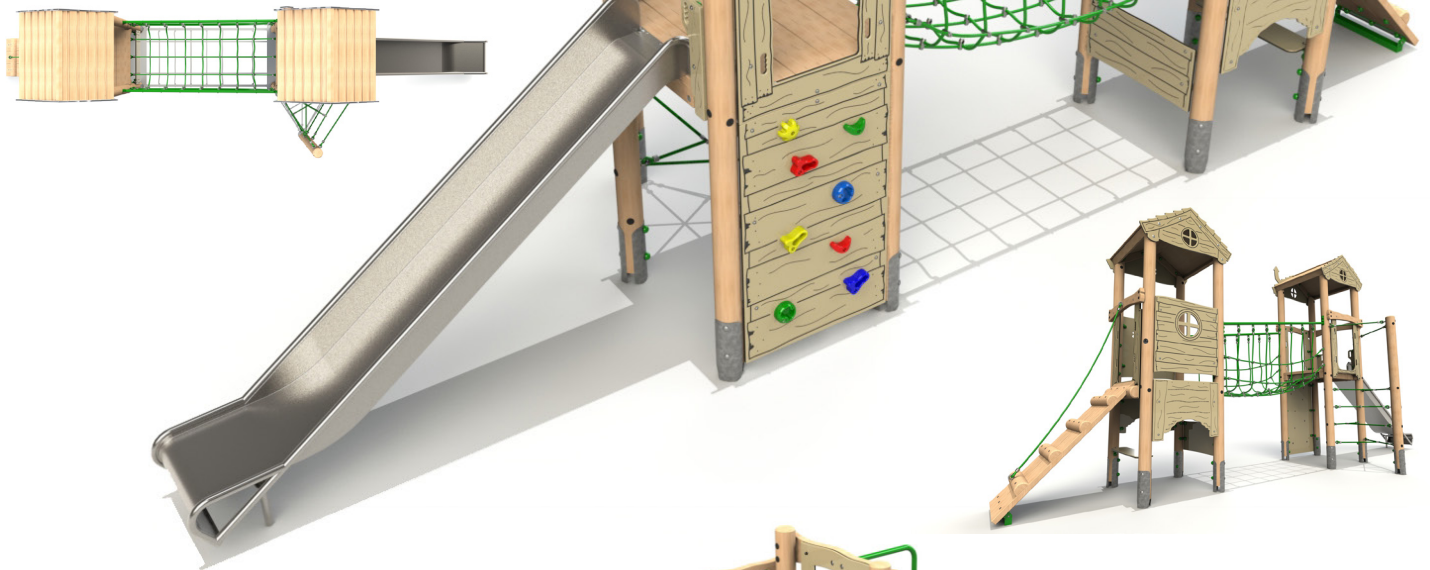

## Double Deck Unit 5

### Product Dimensions

5124mm (L) 4183mm (W) 2945mm (H)

Minimum Surface Area: 50.04m<sup>2</sup>

8592mm (L) 7236mm (W)

Free Fall Height: 1800mm

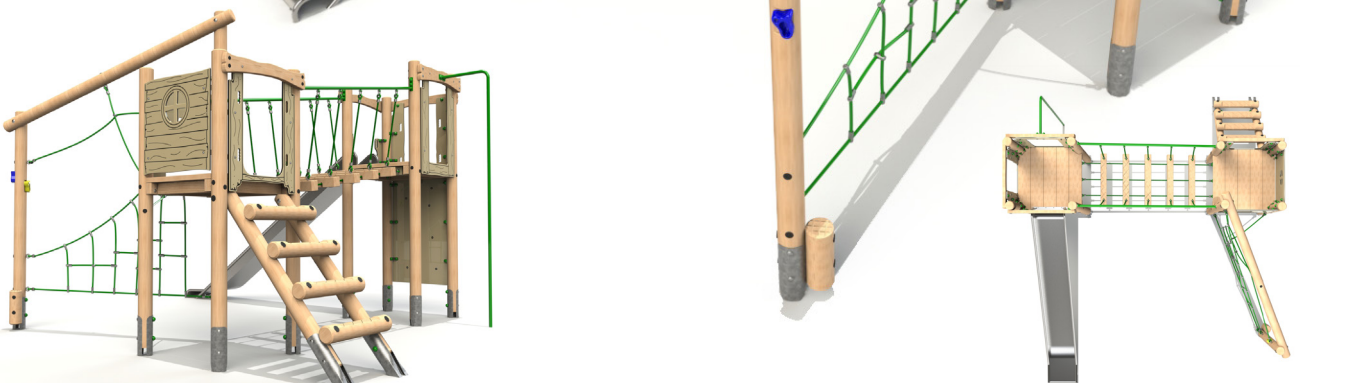

Bespoke Towers available, enquire for more information.



## Alt Double Deck Unit 1

### Product Dimensions

4678mm (L) 3090mm (W) 3149mm (H)

### Minimum Surface Area: 34.61m<sup>2</sup>

8136mm (L) 6143mm (W)

Free Fall Height: 1200mm

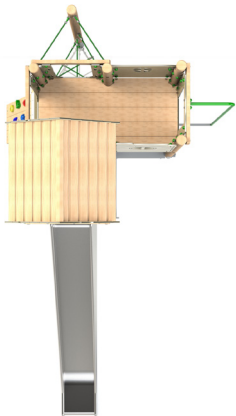

## Alt Double Deck Unit 2

### Product Dimensions

5711mm (L) 3099mm (W) 3799mm (H)

### Minimum Surface Area: 36.67m<sup>2</sup>

9173mm (L) 6082mm (W)

Free Fall Height: 1800mm



Steel feet as standard, bespoke rope colours available.



# Timber Towers

## Alt Double Deck Unit 3

### Product Dimensions

6706mm (L) 2841mm (W) 2605mm (H)

Minimum Surface Area: 41.6m<sup>2</sup>

10175mm (L) 5813mm (W)

Free Fall Height: 1500mm

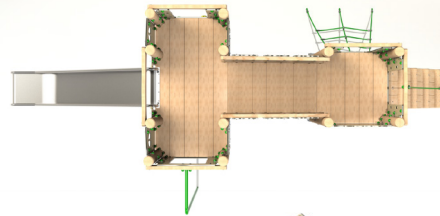
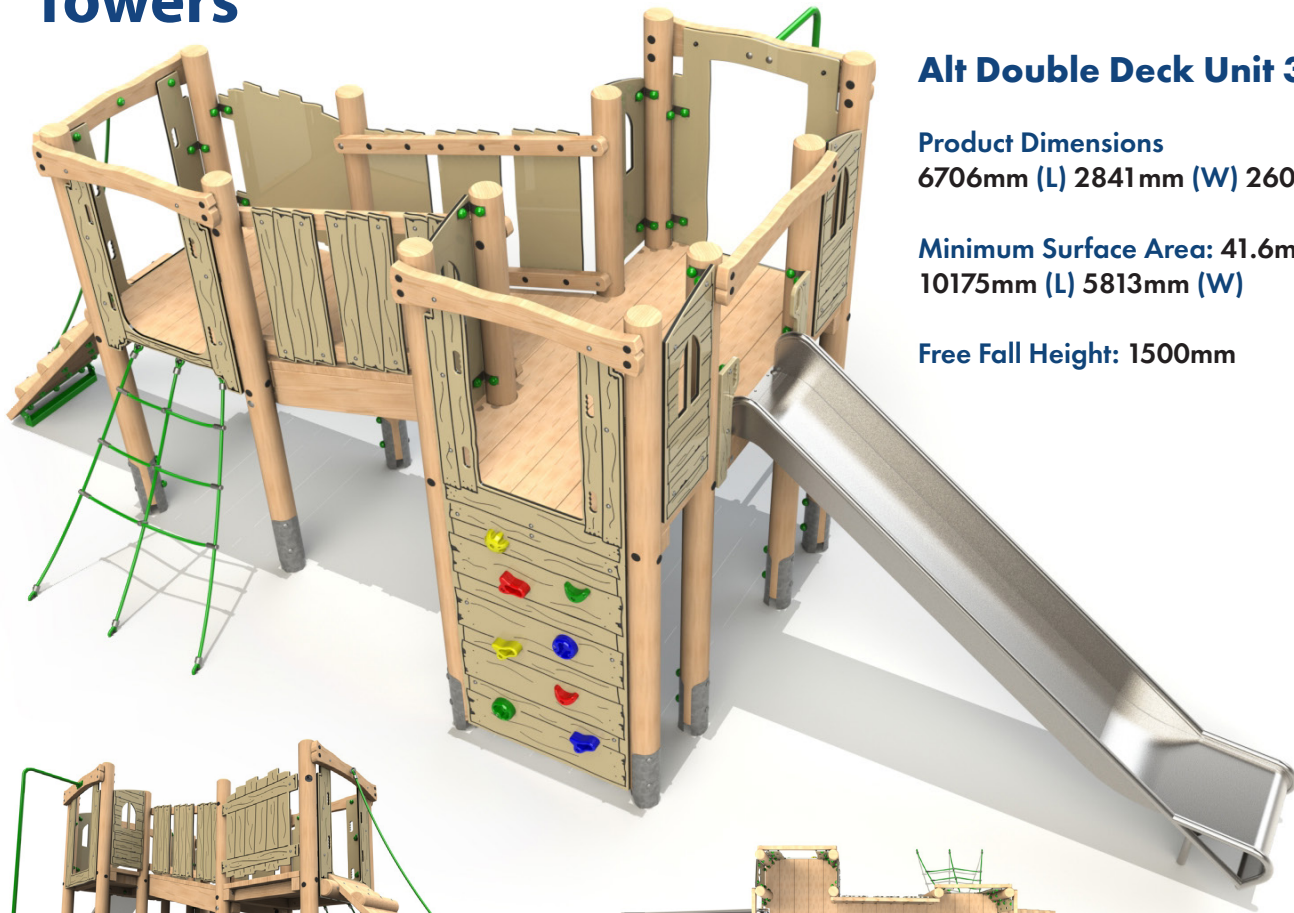

## Alt Double Deck Unit 4

### Product Dimensions

4233mm (L) 3880mm (W) 3699mm (H)

Minimum Surface Area: 35.57m<sup>2</sup>

7363mm (L) 7216mm (W)

Free Fall Height: 1500mm

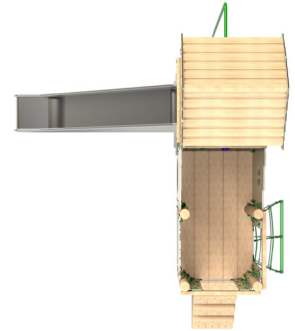
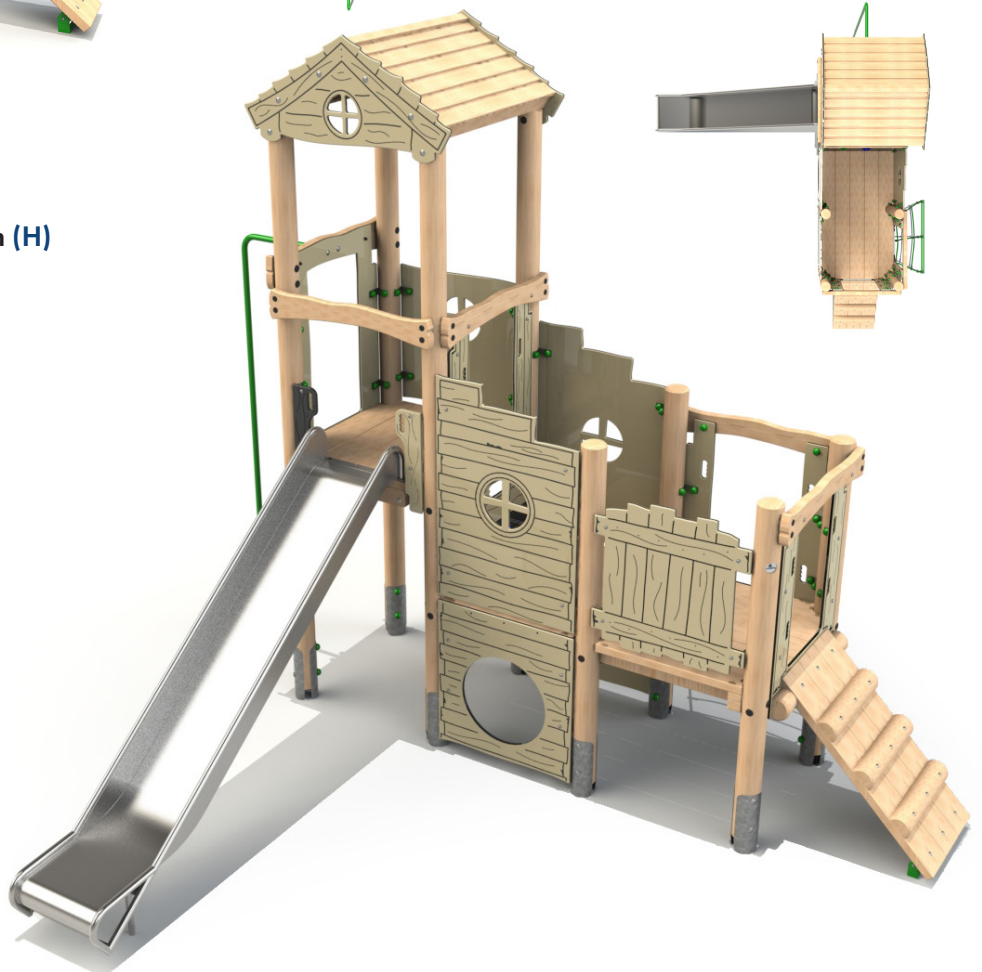

Bespoke Towers available, enquire for more information.



## Triple Deck Unit 1

### Product Dimensions

6638mm (L) 4081mm (W) 2310mm (H)

Minimum Surface Area: 52.58m<sup>2</sup>

10090mm (L) 7036mm (W)

Free Fall Height: 1200mm

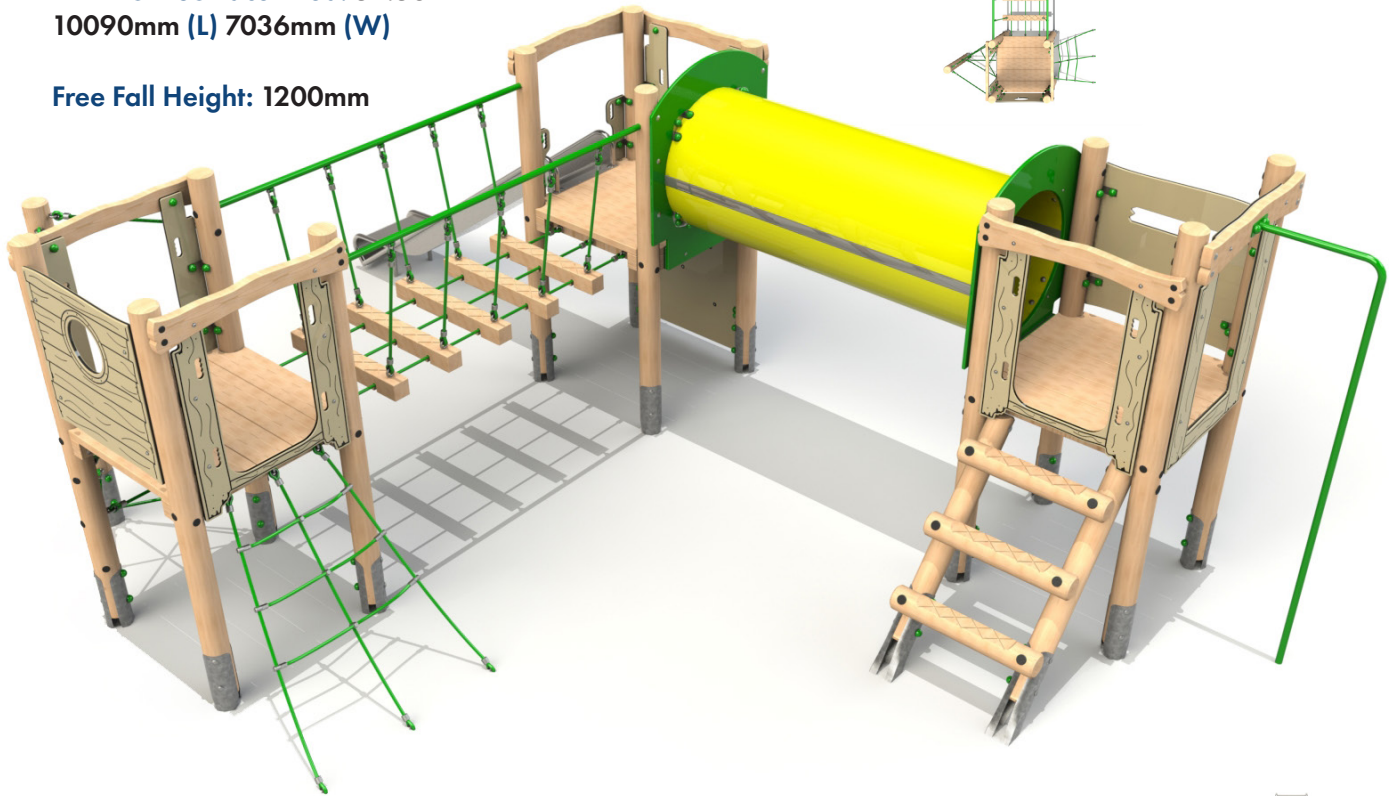
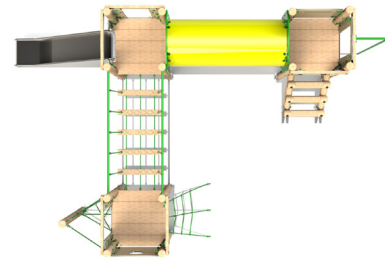

## Triple Deck Unit 2

### Product Dimensions

6377mm (L) 5803mm (W) 3699mm (H)

Minimum Surface Area: 53.78m<sup>2</sup>

9846mm (L) 8786mm (W)

Free Fall Height: 1500mm

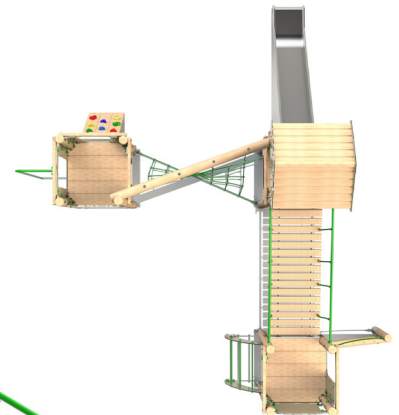

Steel feet as standard, bespoke rope colours available.



# Timber Towers

## Triple Deck Unit 3

### Product Dimensions

7099mm (L) 4489mm (W) 3399mm (H)

Minimum Surface Area: 56.78m<sup>2</sup>

10054mm (L) 7958mm (W)

Free Fall Height: 1500mm

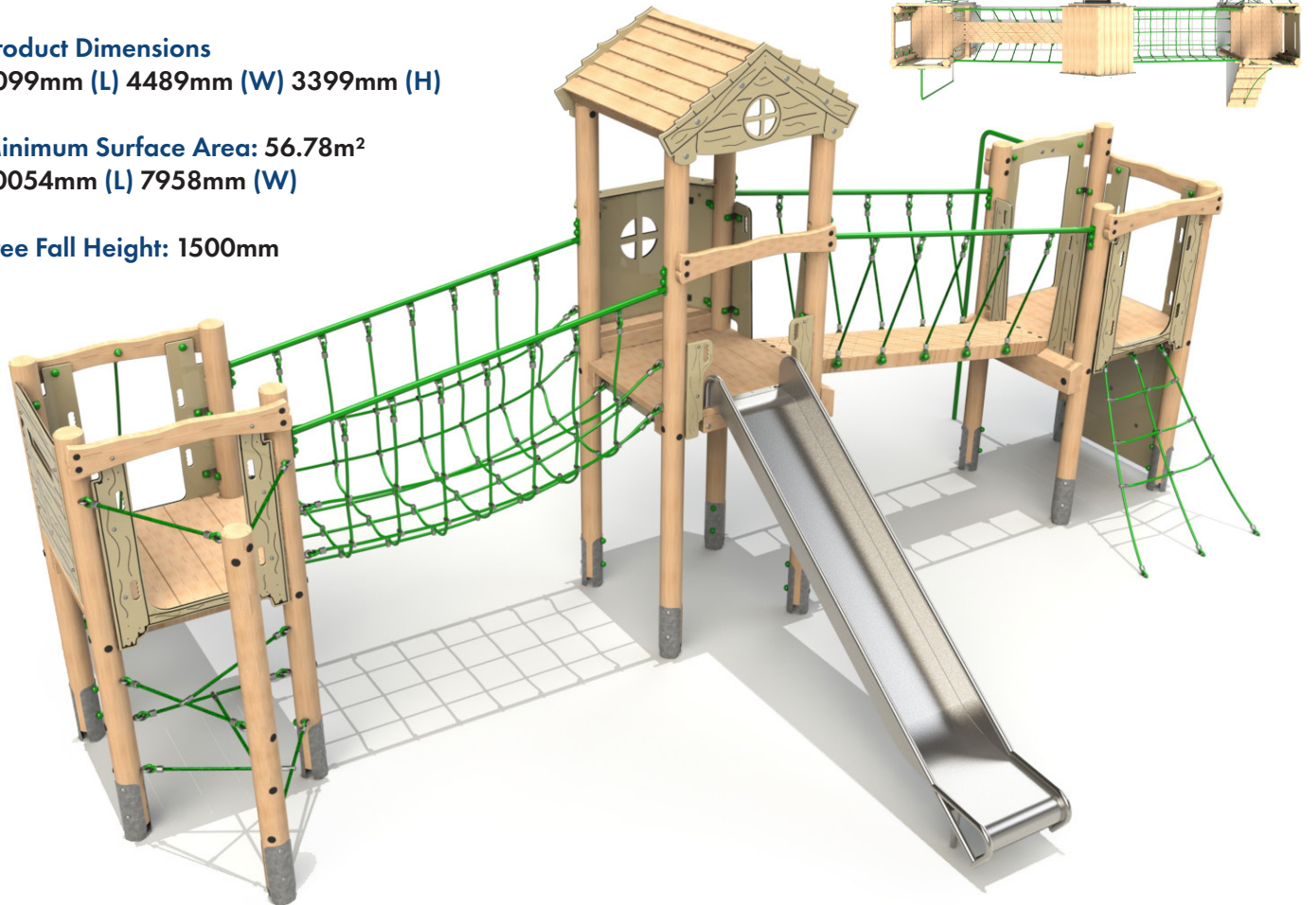

## Triple Deck Unit 4

### Product Dimensions

6982mm (L) 5059mm (W) 3449mm (H)

Minimum Surface Area: 54.83m<sup>2</sup>

10435mm (L) 7992mm (W)

Free Fall Height: 1677mm

Bespoke Towers available, enquire for more information.



## Four Deck Unit 1

### Product Dimensions

6546mm (L) 4664mm (W) 3149mm (H)

Minimum Surface Area: 58.06m<sup>2</sup>

9410mm (L) 7620mm (W)

Free Fall Height: 1200mm

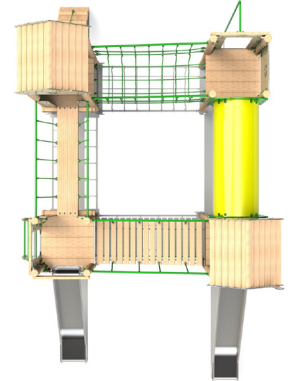
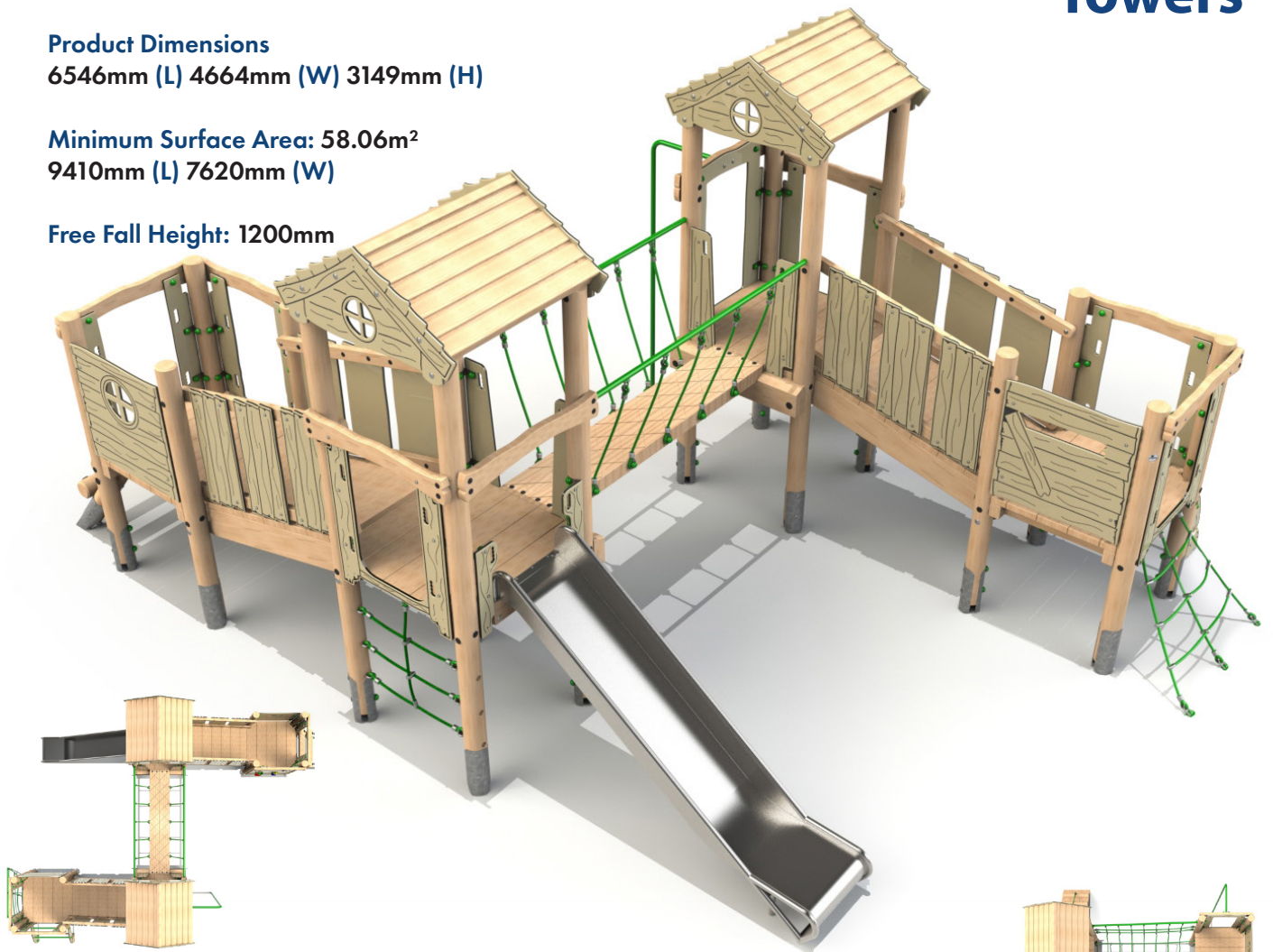

## Four Deck Unit 2

### Product Dimensions

7508mm (L) 4630mm (W)

3501mm (H)

Minimum Surface Area: 69.74m<sup>2</sup>

10977mm (L) 7576mm (W)

Free Fall Height: 1500mm

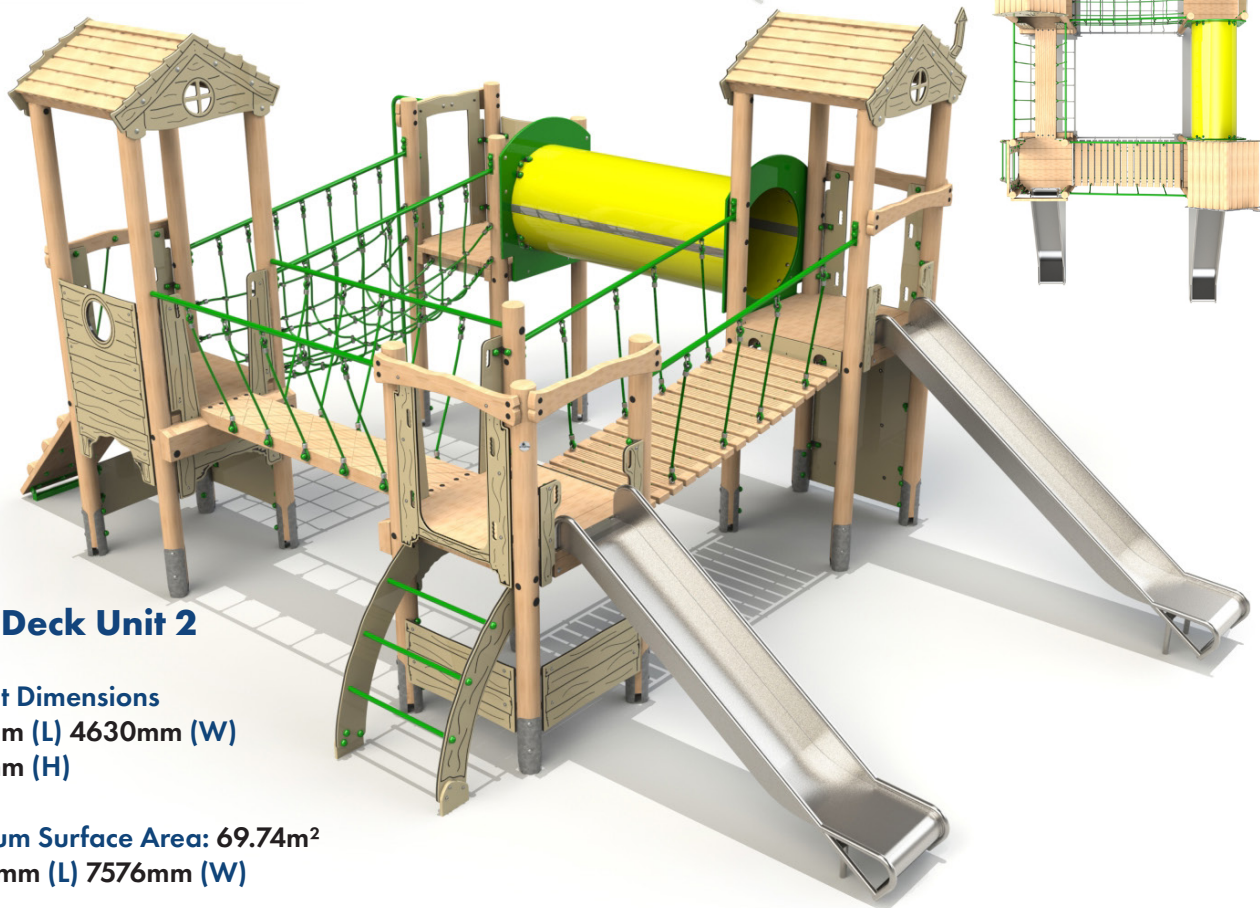

Steel feet as standard, bespoke rope colours available.



# Timber Towers

## Four Deck Unit 3

### Product Dimensions

8194mm (L) 5243mm (W) 3449mm (H)

Minimum Surface Area: 74.33m<sup>2</sup>

11186mm (L) 8196mm (W)

Free Fall Height: 1500mm



## Four Deck Unit 4

### Product Dimensions

10371mm (L) 4131mm (W) 2970mm (H)

Minimum Surface Area: 62.32m<sup>2</sup>

13360mm (L) 7600mm (W)

Free Fall Height: 1500mm

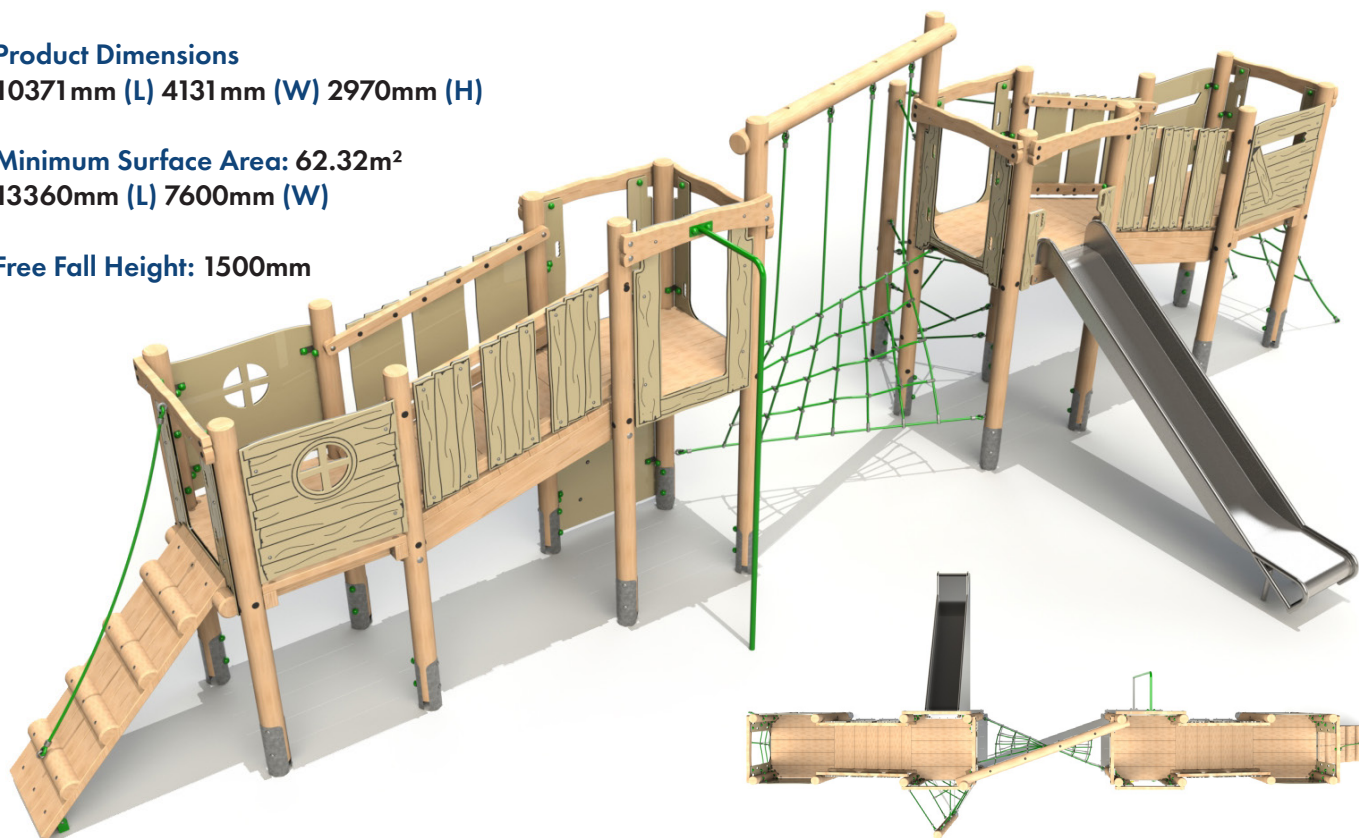

Bespoke Towers available, enquire for more information.



## Alt Four Deck Unit 1

### Product Dimensions

6313mm (L) 6107mm (W) 3799mm (H)

Minimum Surface Area: 63.92m<sup>2</sup>

9289mm (L) 9099mm (W)

Free Fall Height: 1895mm

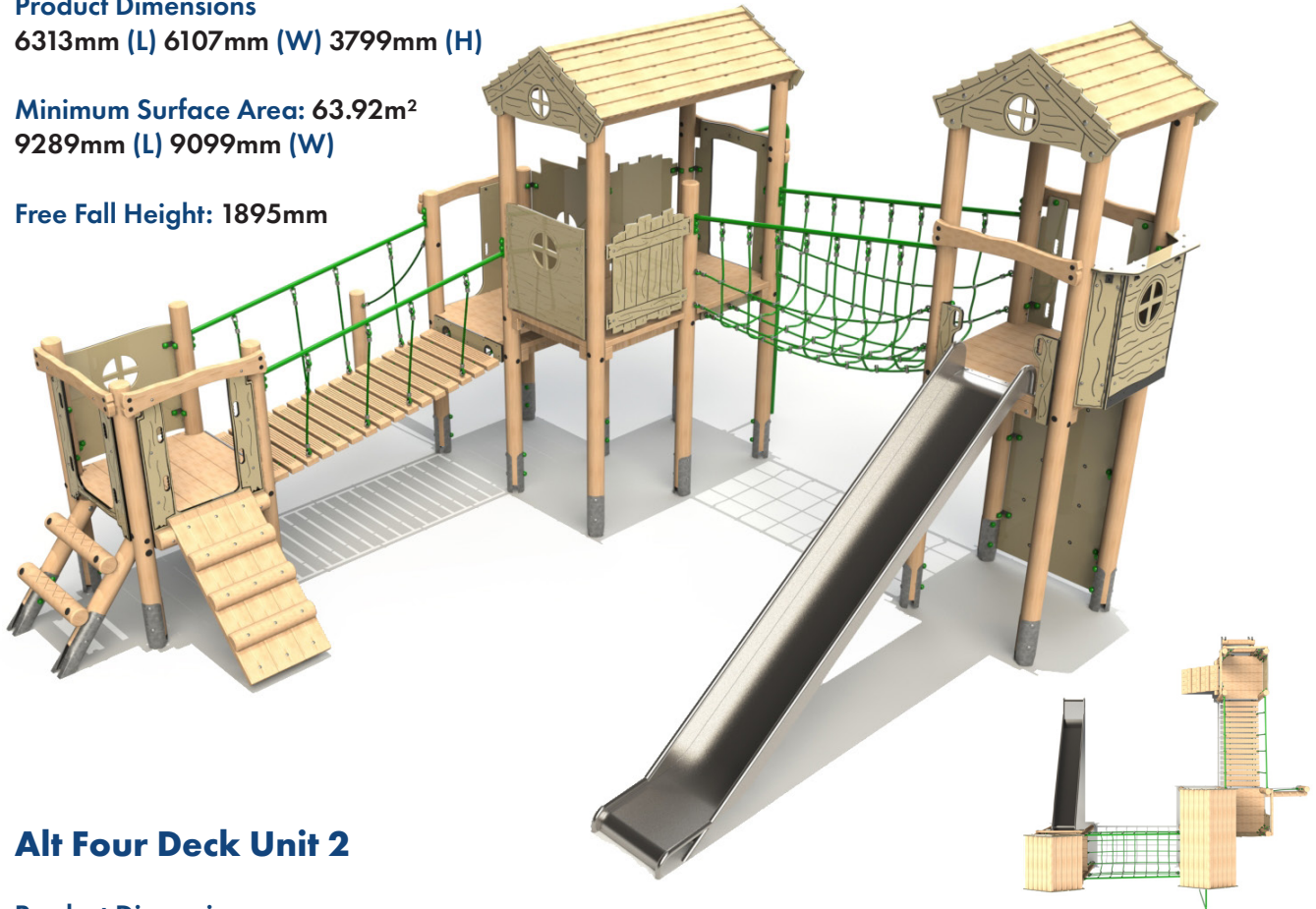

## Alt Four Deck Unit 2

### Product Dimensions

9403mm (L) 8049mm (W) 2905mm (H)

Minimum Surface Area: 79.2m<sup>2</sup>

13332mm (L) 11038mm (W)

Free Fall Height: 1800mm

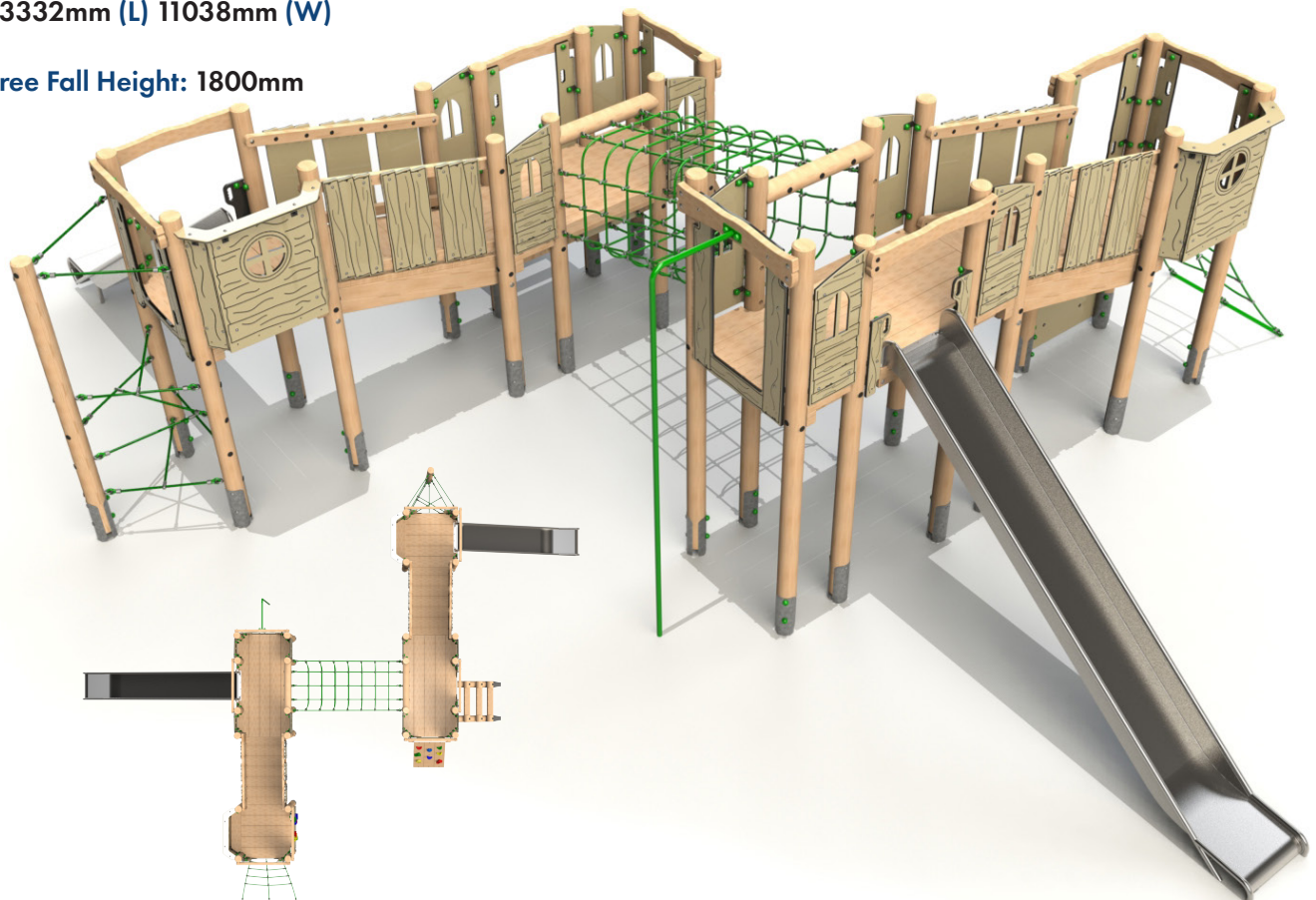

Steel feet as standard, bespoke rope colours available.



# Timber Towers

## Alt Four Deck Unit 3

### Product Dimensions

7787mm (L) 5579mm (W) 2745mm (H)

Minimum Surface Area: 68.53m<sup>2</sup>

11249mm (L) 8718mm (W)

Free Fall Height: 1800mm



## Castle Tower 1

### Product Dimensions

3965mm (L) 2524mm (W) 3425mm (H)

Minimum Surface Area: 28.96m<sup>2</sup>

7408mm (L) 5449mm (W)

Free Fall Height: 1500mm

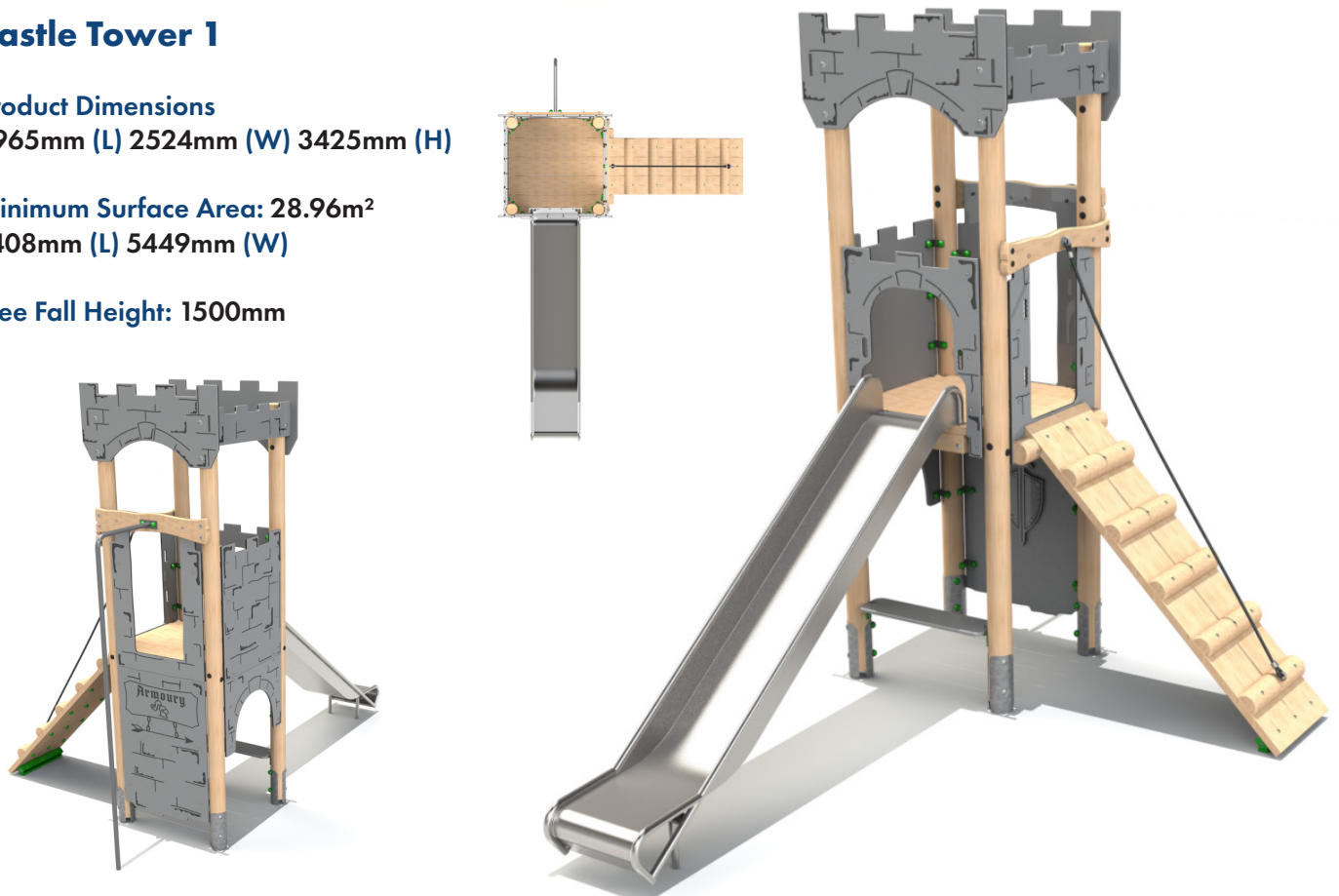

Bespoke Towers available, enquire for more information.



## Castle Tower 2

### Product Dimensions

4696mm (L) 4145mm (W) 3191mm (H)

Minimum Surface Area: 40.33m<sup>2</sup>

7614mm (L) 7554mm (W)

Free Fall Height: 1327mm

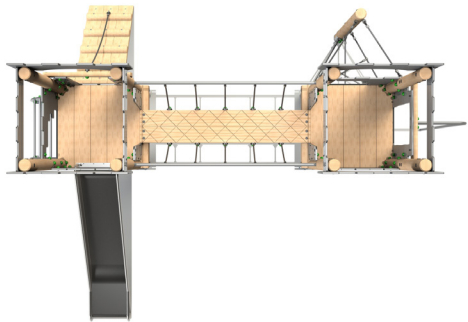
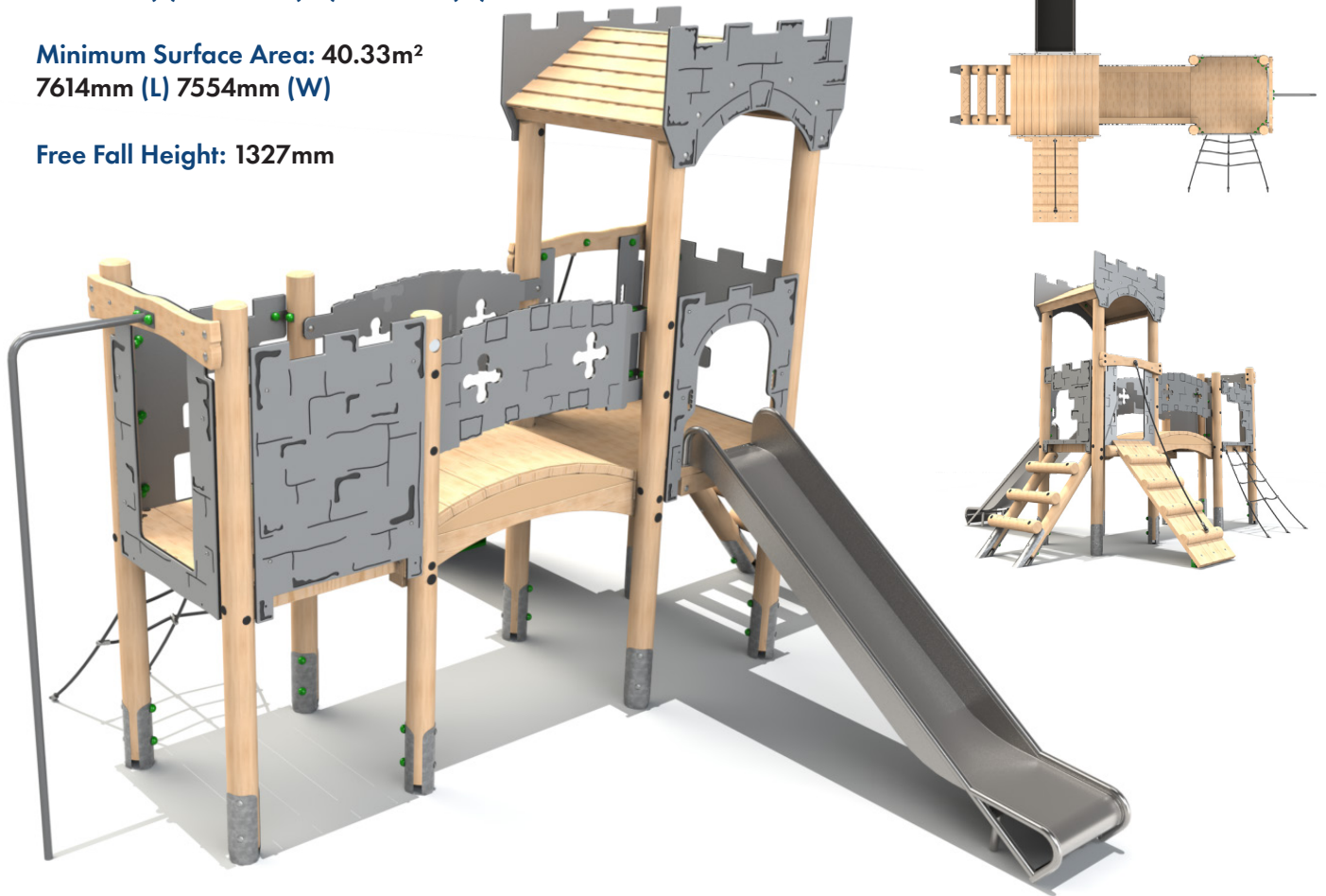

## Castle Tower 3

### Product Dimensions

5185mm (L) 4145mm (W) 3241mm (H)

Minimum Surface Area: 41.6m<sup>2</sup>

8169mm (L) 7614mm (W)

Free Fall Height: 1200mm

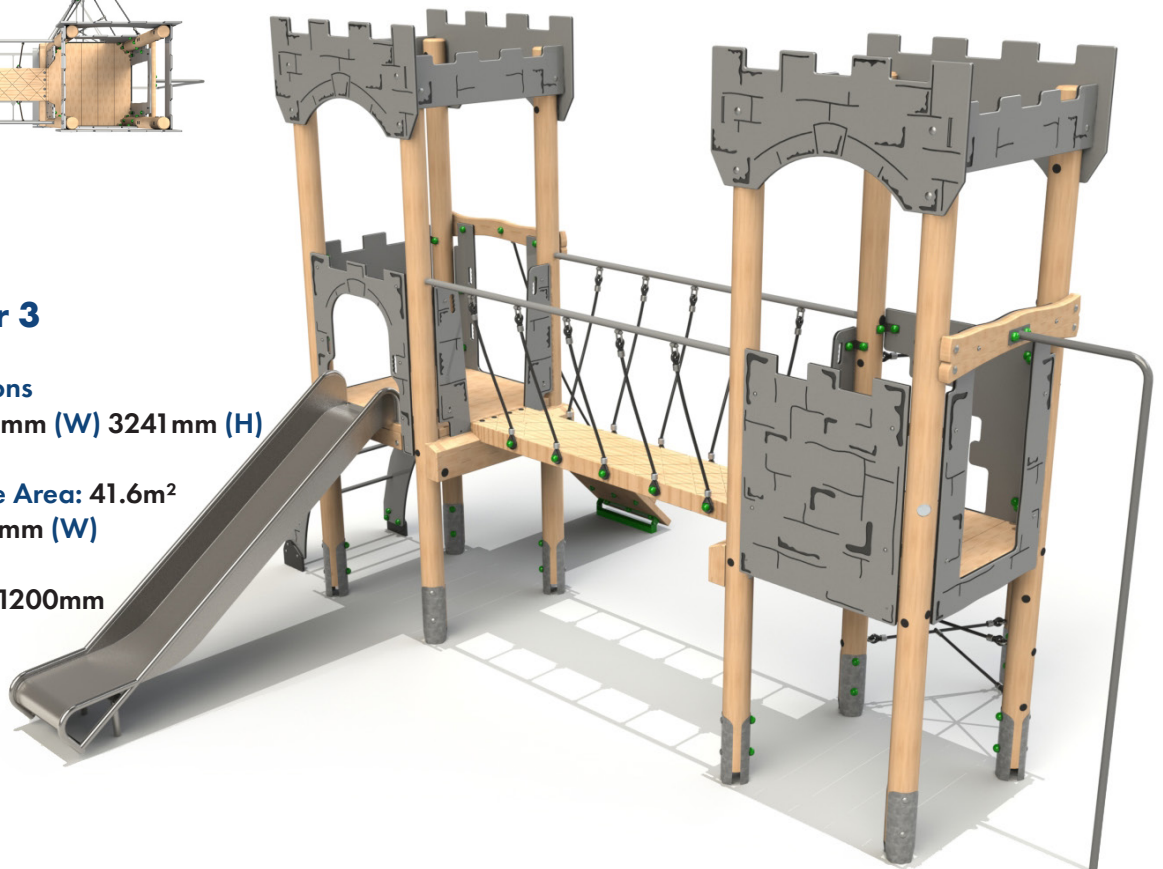

Steel feet as standard, bespoke rope colours available.



# Timber Towers

## Castle Tower 4

### Product Dimensions

4717mm (L) 3903mm (W) 3490mm (H)

### Minimum Surface Area: 41.31m<sup>2</sup>

7625mm (L) 7371mm (W)

Free Fall Height: 1500mm

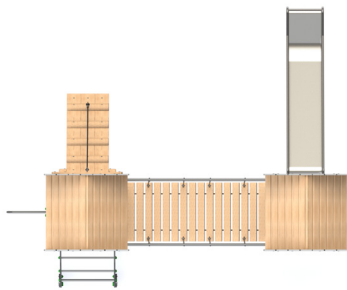

## Castle Tower 5

### Product Dimensions

5684mm (L) 3965mm (W) 3460mm (H)

### Minimum Surface Area: 42.57m<sup>2</sup>

8693mm (L) 7417mm (W)

Free Fall Height: 1500mm

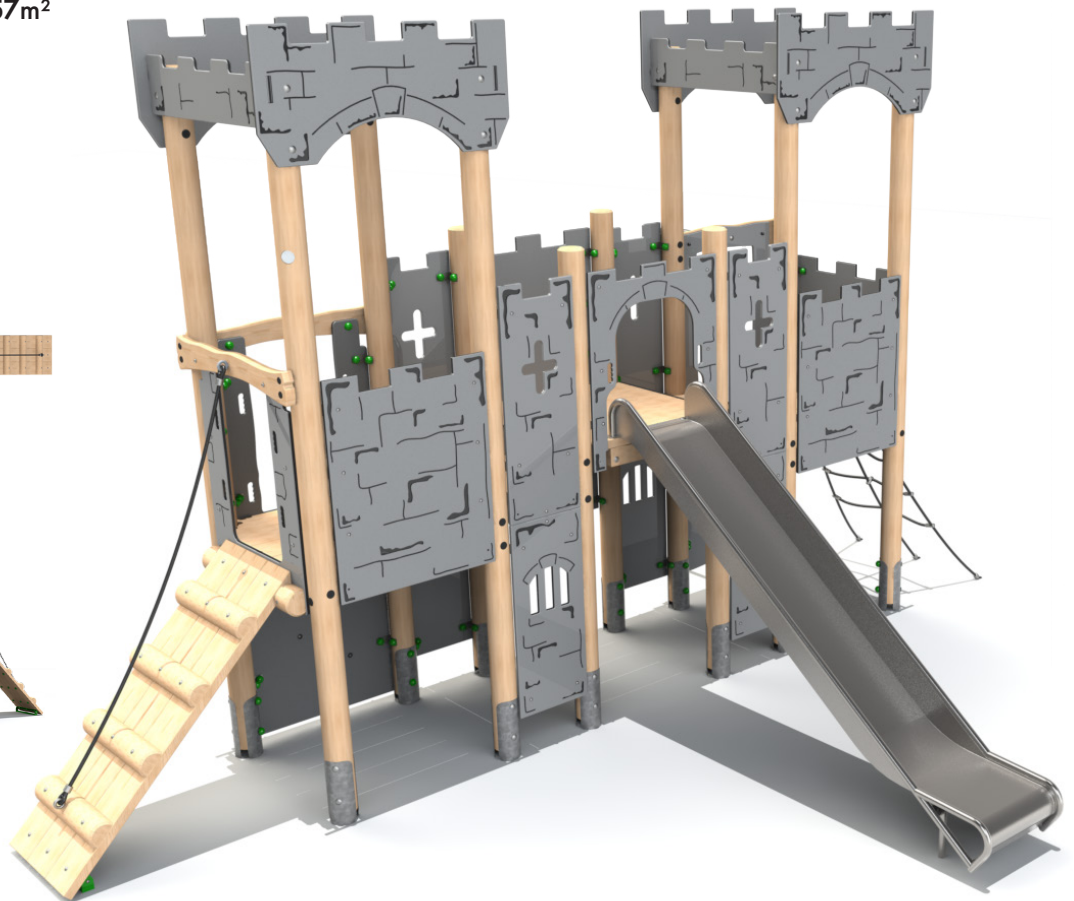
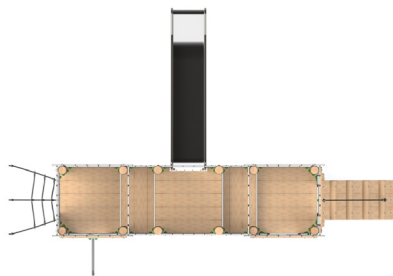

Bespoke Towers available, enquire for more information.



# Timber Towers



## Castle Tower 6

### Product Dimensions

5242mm (L) 4603mm (W)  
3491mm (H)

Minimum Surface Area: 51.32m<sup>2</sup>  
8167mm (L) 7611mm (W)

Free Fall Height: 1500mm

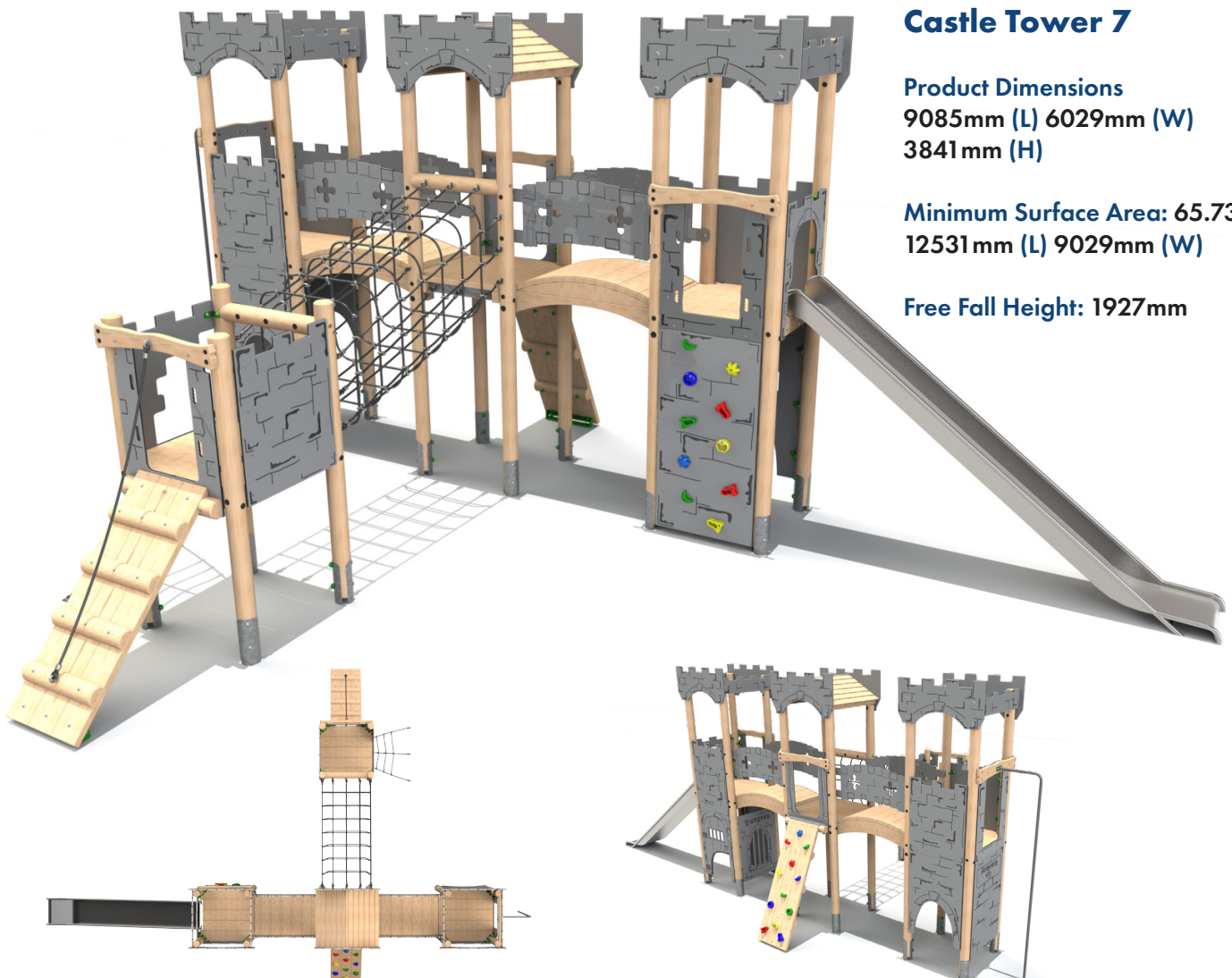

## Castle Tower 7

### Product Dimensions

9085mm (L) 6029mm (W)  
3841mm (H)

Minimum Surface Area: 65.73m<sup>2</sup>  
12531mm (L) 9029mm (W)

Free Fall Height: 1927mm

Steel feet as standard, bespoke rope colours available.



# Timber Towers

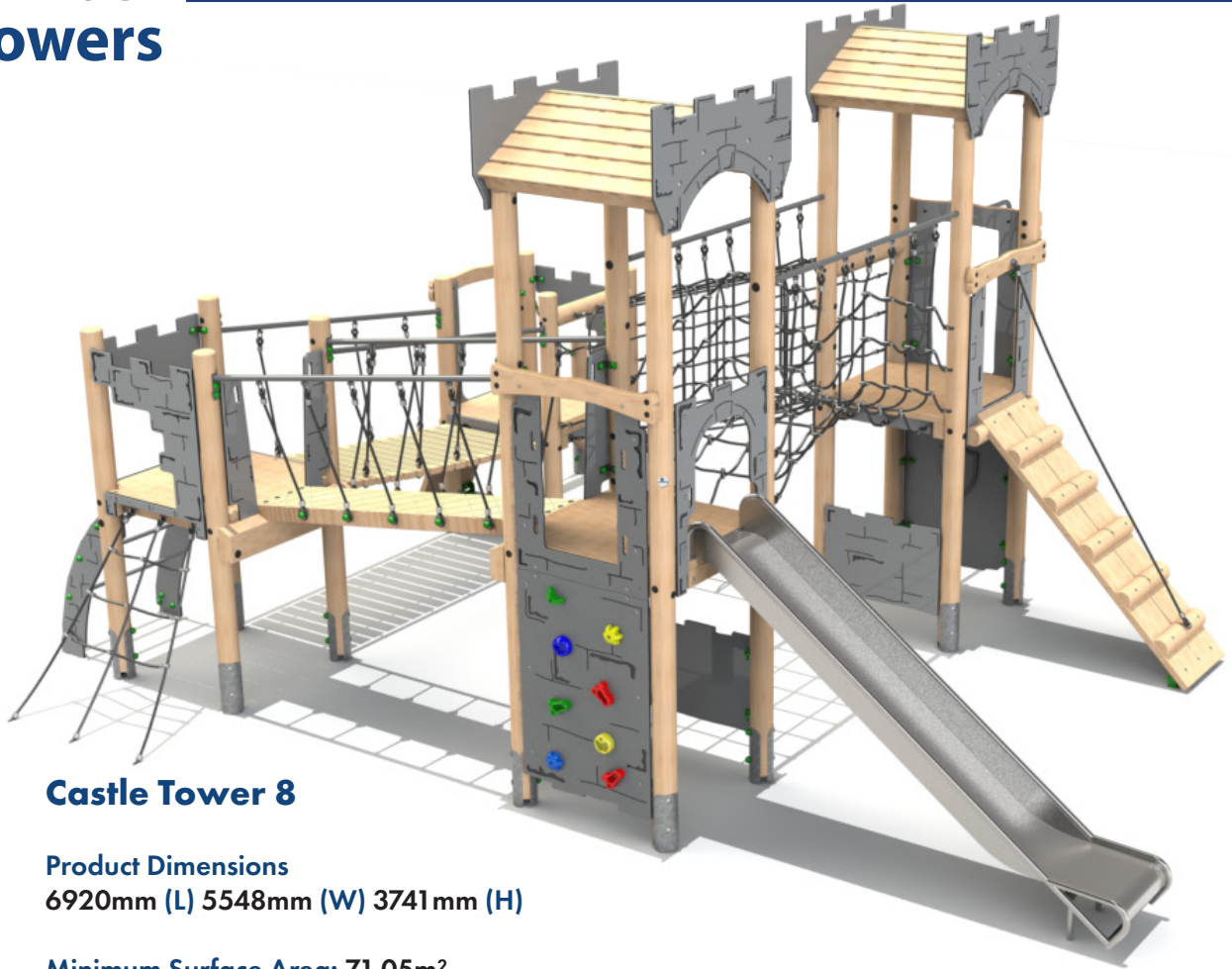

## Castle Tower 8

### Product Dimensions

6920mm (L) 5548mm (W) 3741mm (H)

Minimum Surface Area: 71.05m<sup>2</sup>

10390mm (L) 8556mm (W)

Free Fall Height: 1500mm

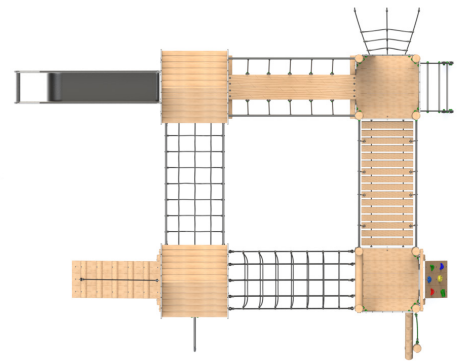

Bespoke Towers available, enquire for more information.





## Castle Tower 9

### Product Dimensions

7599mm (L) 5119mm (W) 3491 mm (H)

Minimum Surface Area: 65.84m<sup>2</sup>

10697mm (L) 8134mm (W)

Free Fall Height: 1500mm

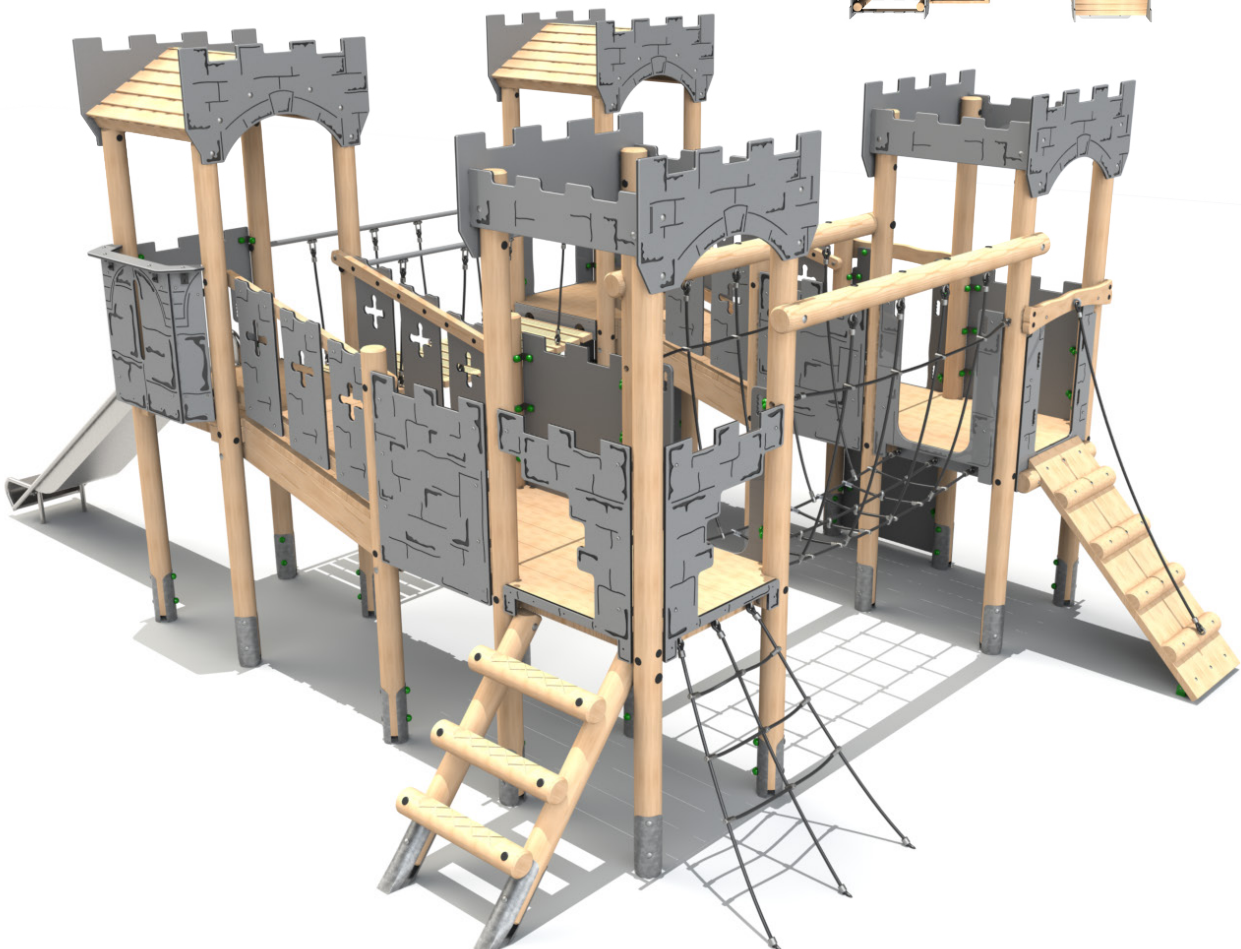
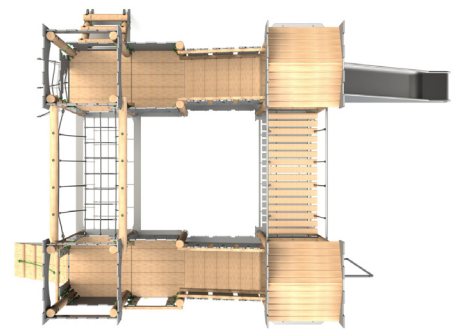

Steel feet as standard, bespoke rope colours available.



# Timber Towers

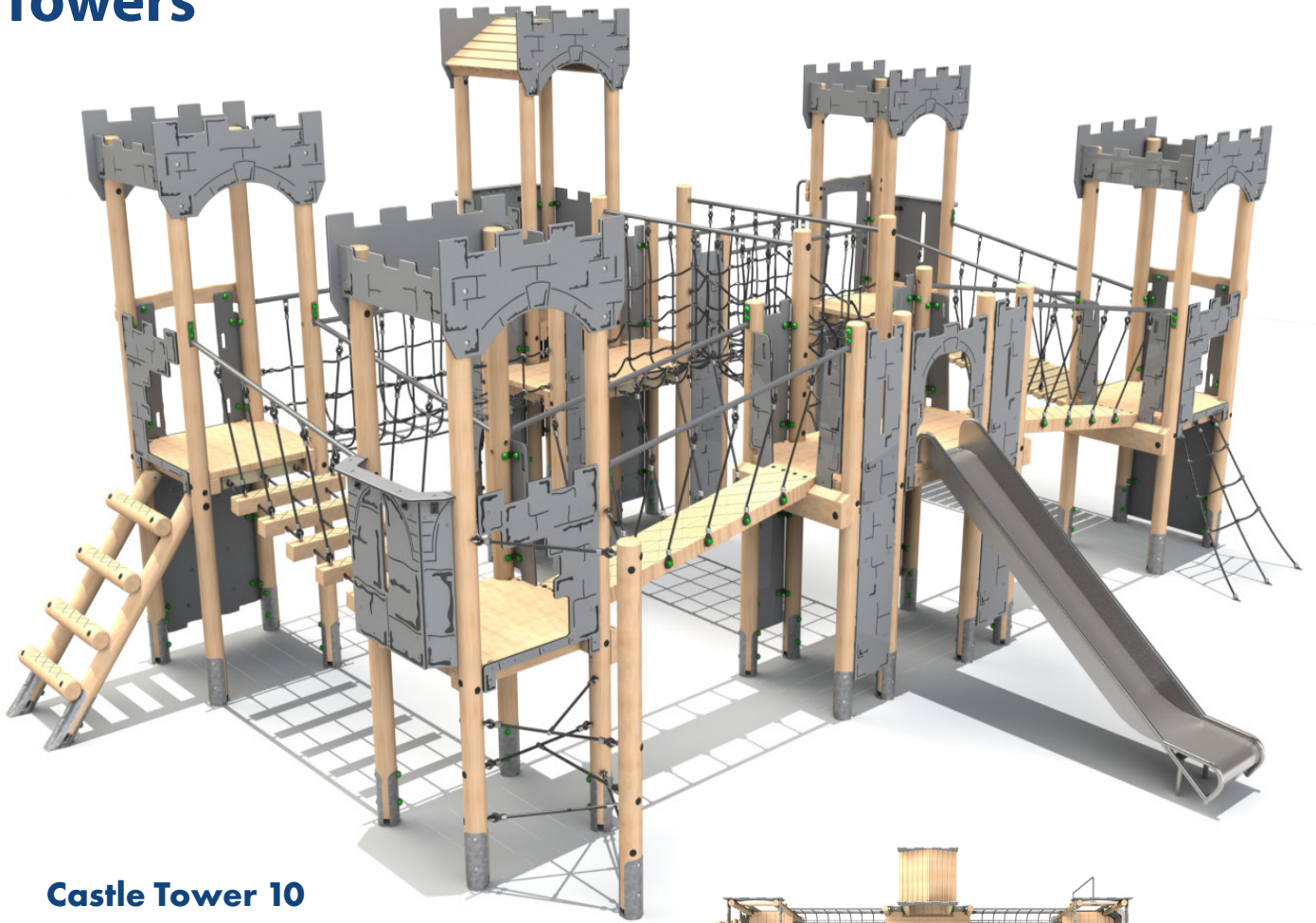

## Castle Tower 10

### Product Dimensions

9243mm (L) 7490mm (W) 4041mm (H)

Minimum Surface Area: 97.08m<sup>2</sup>

12251mm (L) 10929mm (W)

Free Fall Height: 1895mm

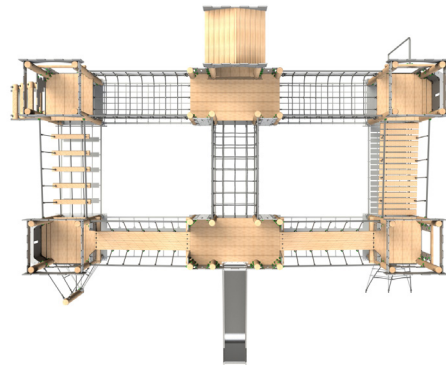

Bespoke Towers available, enquire for more information.



## Clamber Tower 2

### Product Dimensions

6091mm (L) 4842mm (W) 2678mm (H)

### Minimum Surface Area: 54.32m<sup>2</sup>

9257mm (L) 8535mm (W)

Free Fall Height: 1500mm

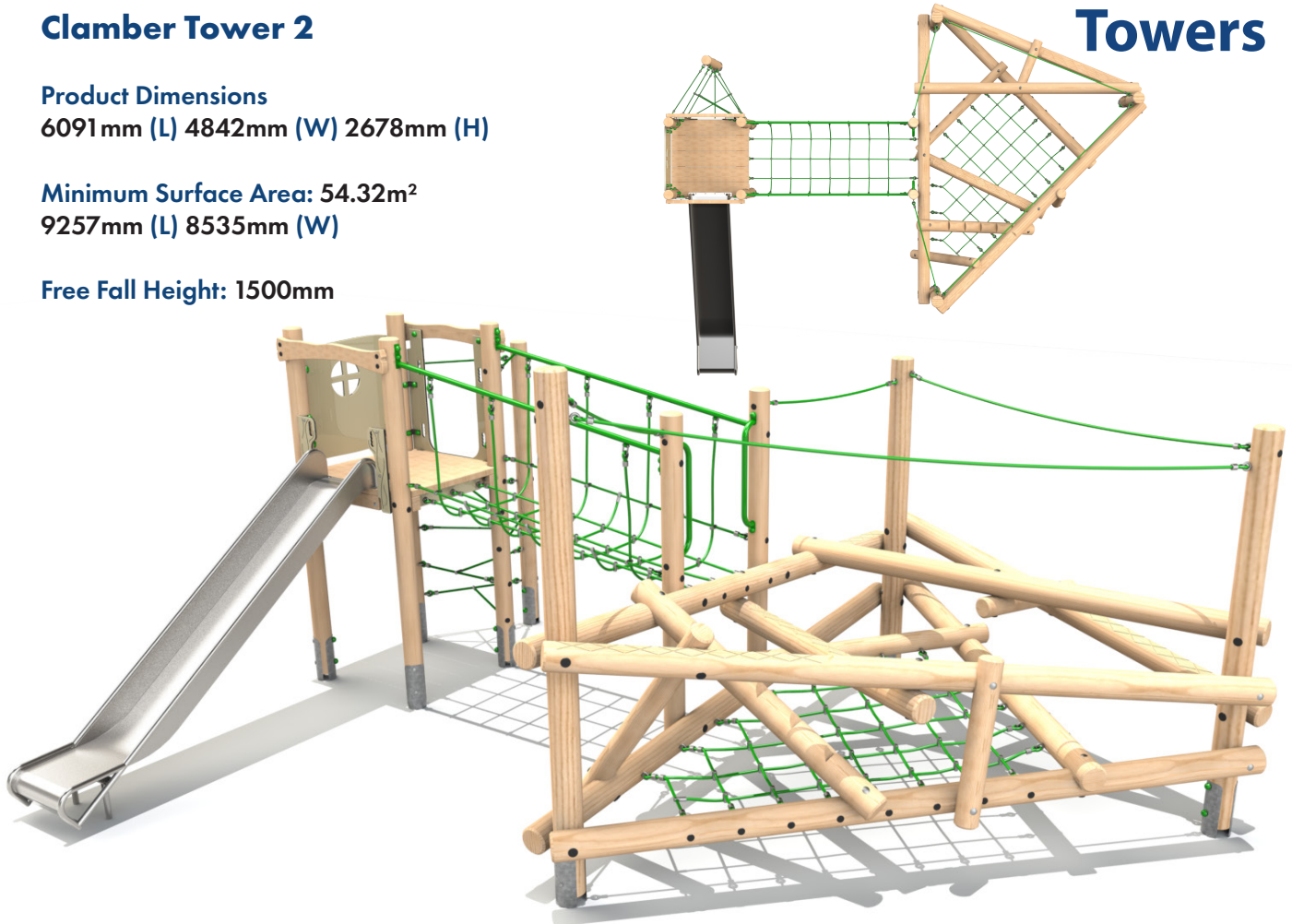

## Clamber Tower 2 Castle

### Product Dimensions

6636mm (L) 4842mm (W)

3535mm (H)

### Minimum Surface Area: 54.54m<sup>2</sup>

9802mm (L) 8535mm (W)

Free Fall Height: 1500mm

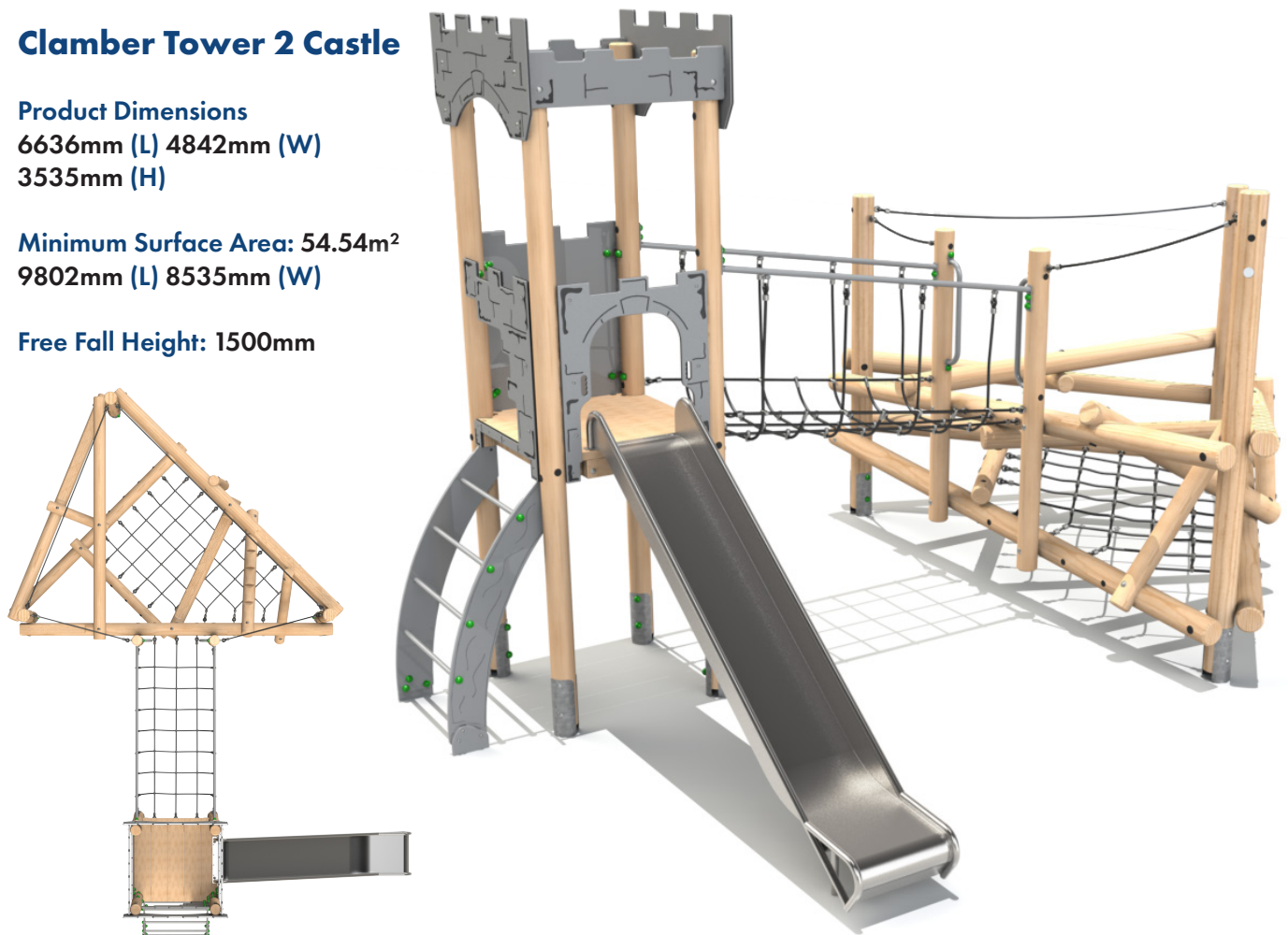

Steel feet as standard, bespoke rope colours available.



# Timber Towers

## Clamber Tower Mezzo

**Product Dimensions**  
6372mm (L) 5978mm (W) 2854mm (H)

**Minimum Surface Area: 63.91m<sup>2</sup>**  
9366mm (L) 9477mm (W)

**Free Fall Height: 1500mm**

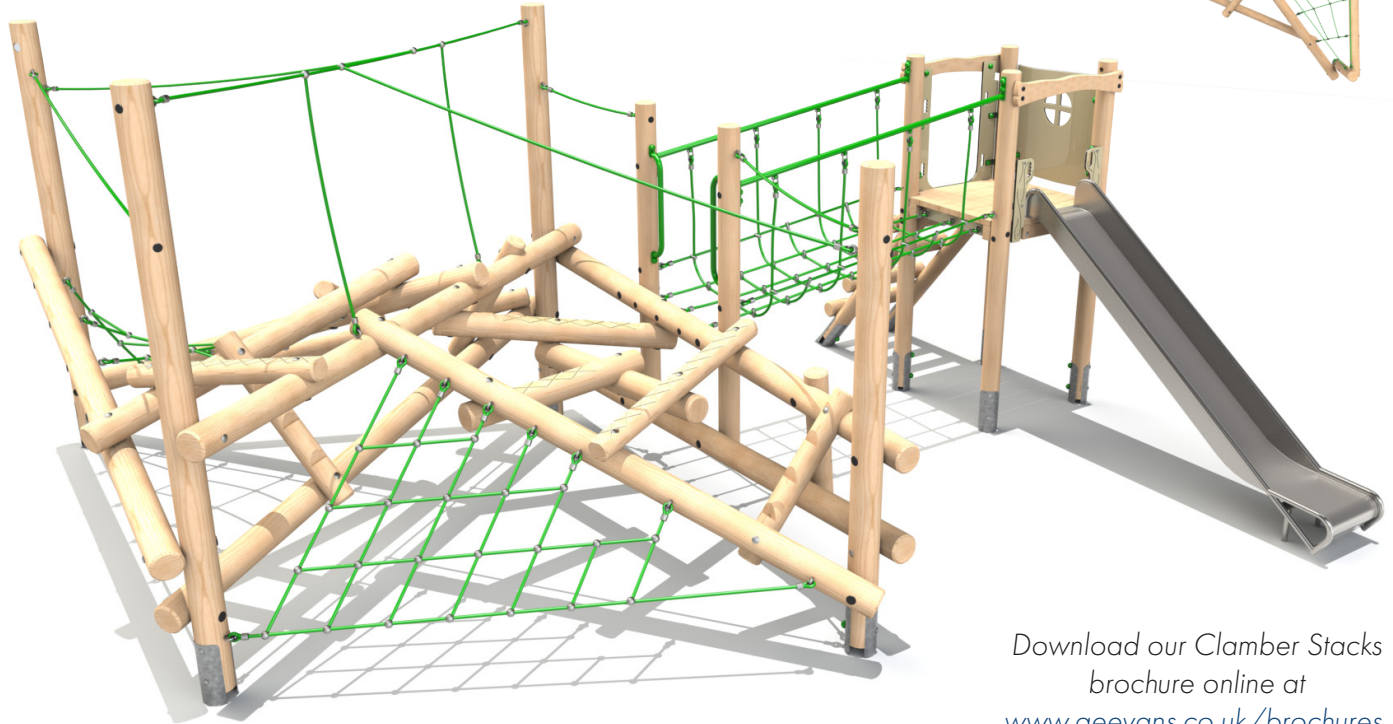

Download our Clamber Stacks brochure online at [www.aeevans.co.uk/brochures](http://www.aeevans.co.uk/brochures).

## Clamber Tower 3 Double Deck Castle

**Product Dimensions**  
9484mm (L) 5543mm (W)  
3740mm (H)

**Minimum Surface Area: 78.91m<sup>2</sup>**  
13081mm (L) 8467mm (W)

**Free Fall Height: 1500mm**

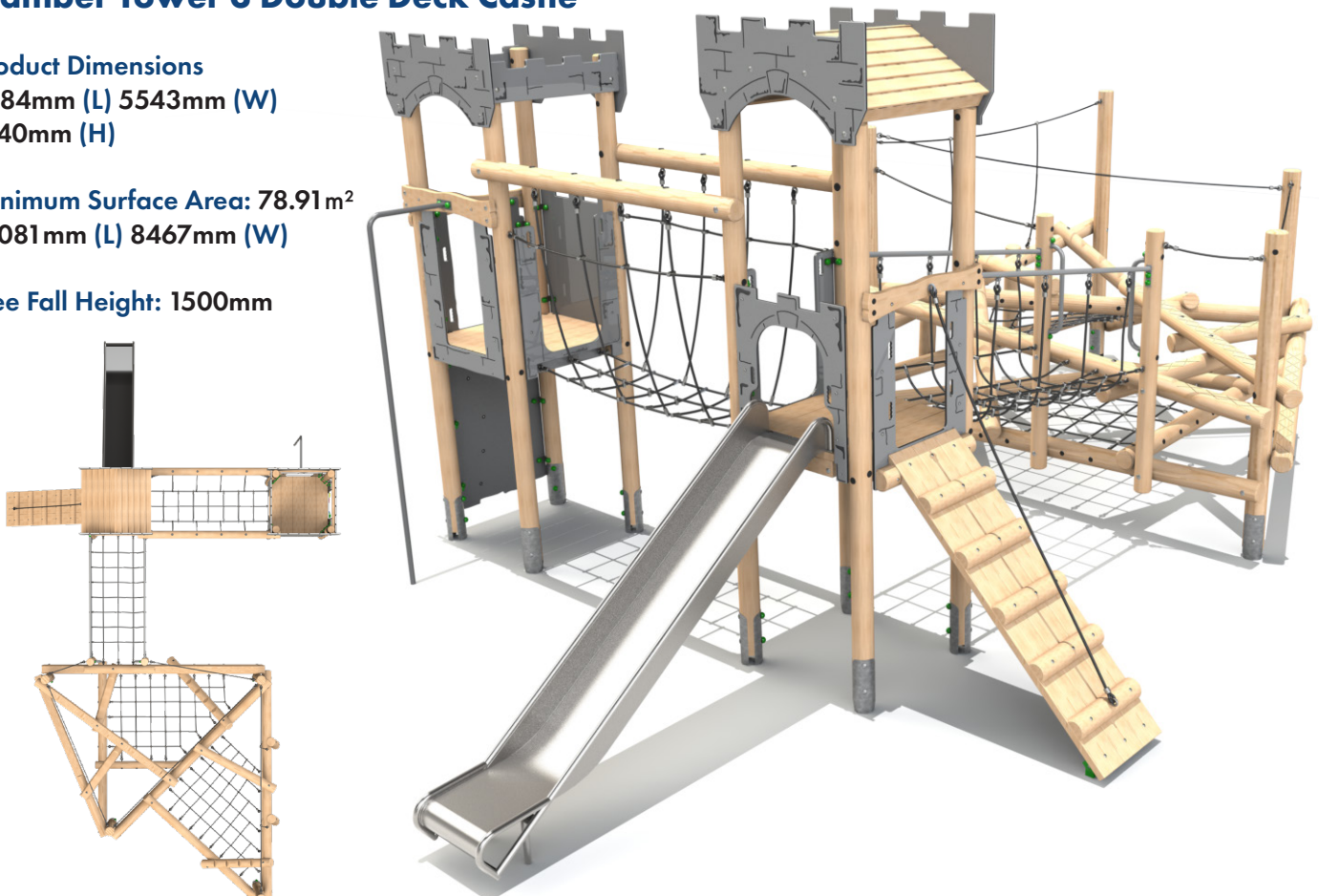

Bespoke Towers available, enquire for more information.



## Clamber Tower 3

### Product Dimensions

7141mm (L) 4278mm (W) 2700mm (H)

Minimum Surface Area: 63.18m<sup>2</sup>

10272mm (L) 7990mm (W)

Free Fall Height: 1500mm

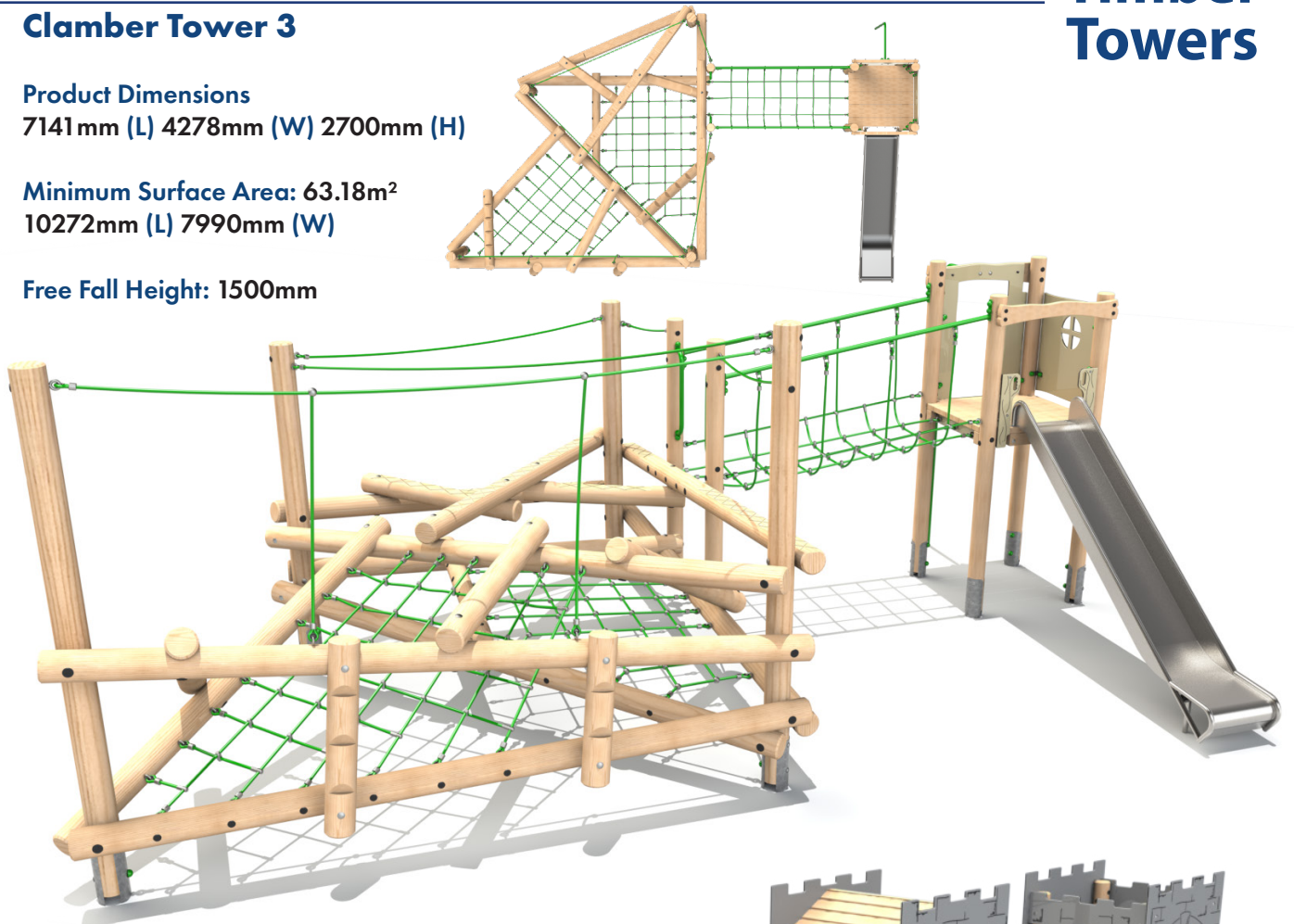

## Clamber Tower 3 Triple Deck Castle

### Product Dimensions

9484mm (L) 8203mm (W) 3737mm (H)

Minimum Surface Area: 91.54m<sup>2</sup>

13081mm (L) 11129mm (W)

Free Fall Height: 1500mm



Steel feet as standard, bespoke rope colours available.



# Timber Towers

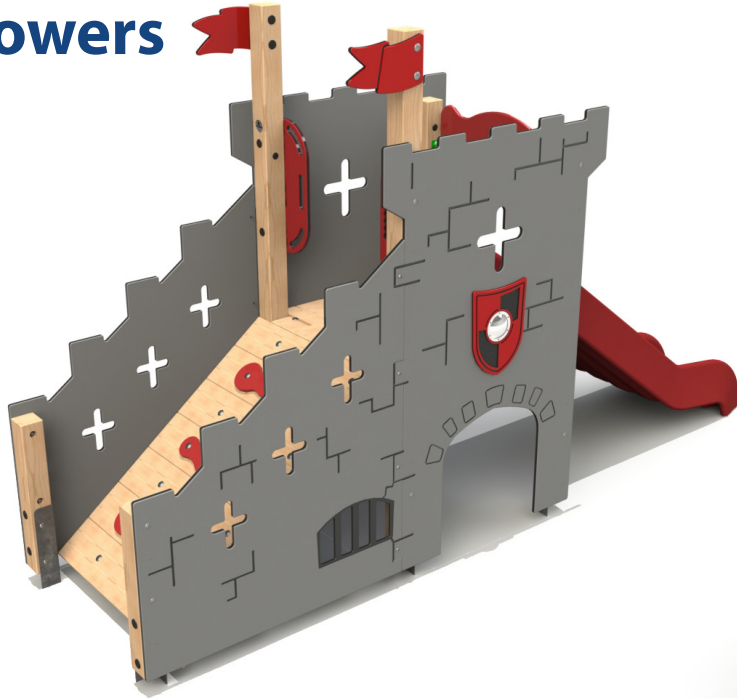

## Castle Slide Unit

### Product Dimensions

3830mm (L) 1090mm (W) 2270mm (H)

Minimum Surface Area: 24.5m<sup>2</sup>

7160mm (L) 3990mm (W)

Free Fall Height: 900mm

## Boat Slide Unit

### Product Dimensions

3830mm (L) 1120mm (W) 2170mm (H)

Minimum Surface Area: 24.5m<sup>2</sup>

7160mm (L) 3990mm (W)

Free Fall Height: 900mm

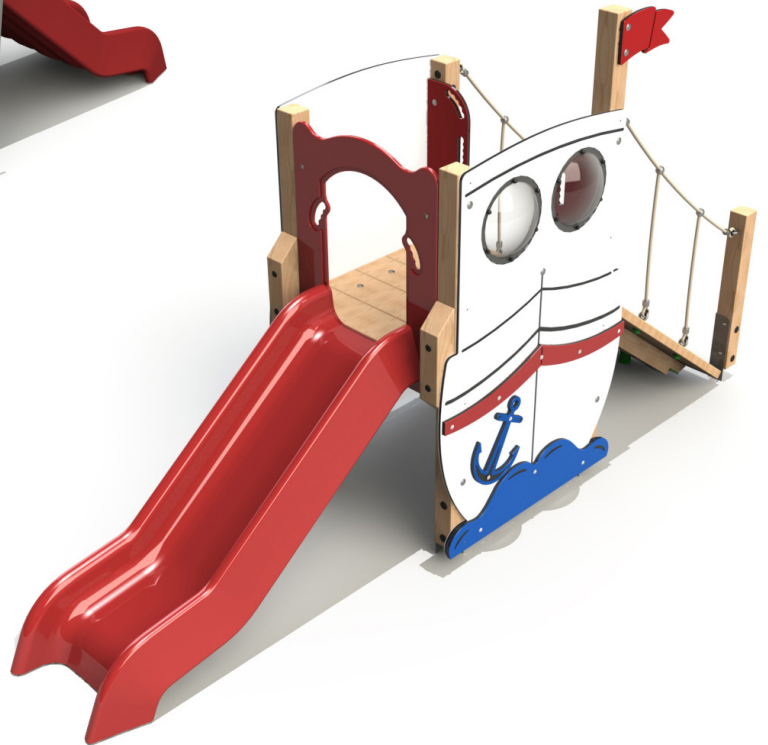

## Dump Truck Slide Unit

### Product Dimensions

4040mm (L) 1060mm (W) 1810mm (H)

Minimum Surface Area: 24.5m<sup>2</sup>

7160mm (L) 3990mm (W)

Free Fall Height: 900mm



## Elephant Slide Unit

### Product Dimensions

4040mm (L) 1070mm (W)

1730mm (H)

Minimum Surface Area: 24.5m<sup>2</sup>

7160mm (L) 3990mm (W)

Free Fall Height: 900mm

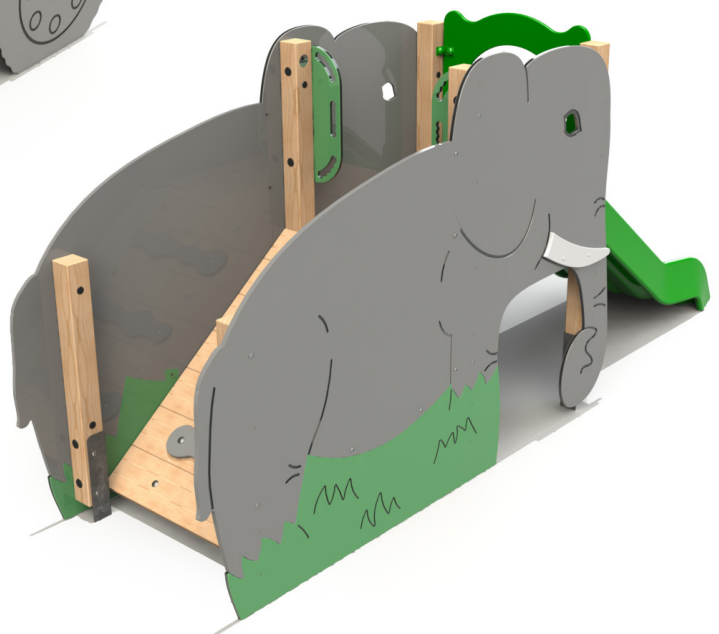

Bespoke Towers available, enquire for more information.



# Timber Towers

## Fire Engine Slide Unit



### Product Dimensions

3880mm (L) 1070mm (W) 1810mm (H)

### Minimum Surface Area: 24.5m<sup>2</sup>

7160mm (L) 3990mm (W)

Free Fall Height: 900mm

## Rocket Slide Unit

### Product Dimensions

3840mm (L) 1180mm (W) 2460mm (H)

### Minimum Surface Area: 24.5m<sup>2</sup>

7160mm (L) 3990mm (W)

Free Fall Height: 900mm

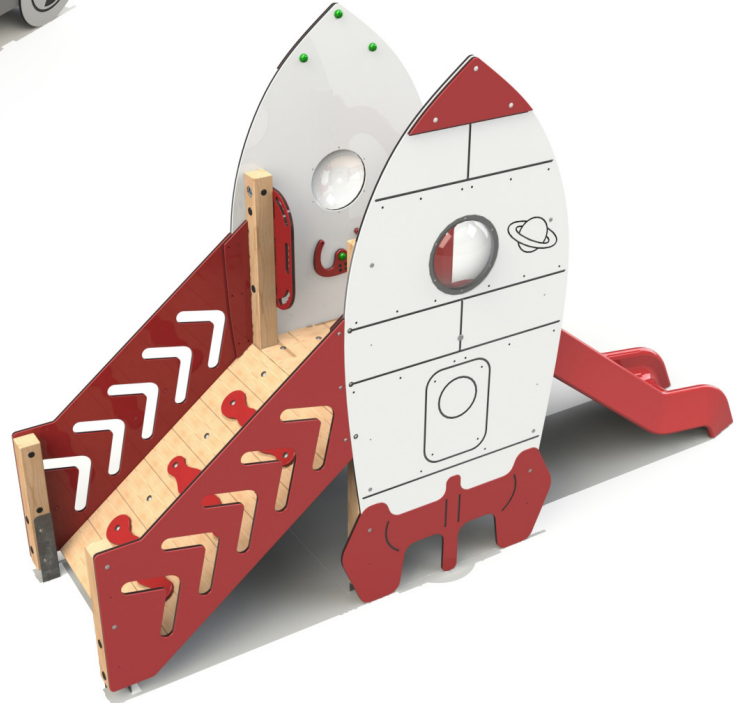

## Submarine Slide Unit

### Product Dimensions

4040mm (L) 1170mm (W) 2310mm (H)

### Minimum Surface Area: 24.5m<sup>2</sup>

7160mm (L) 3990mm (W)

Free Fall Height: 900mm

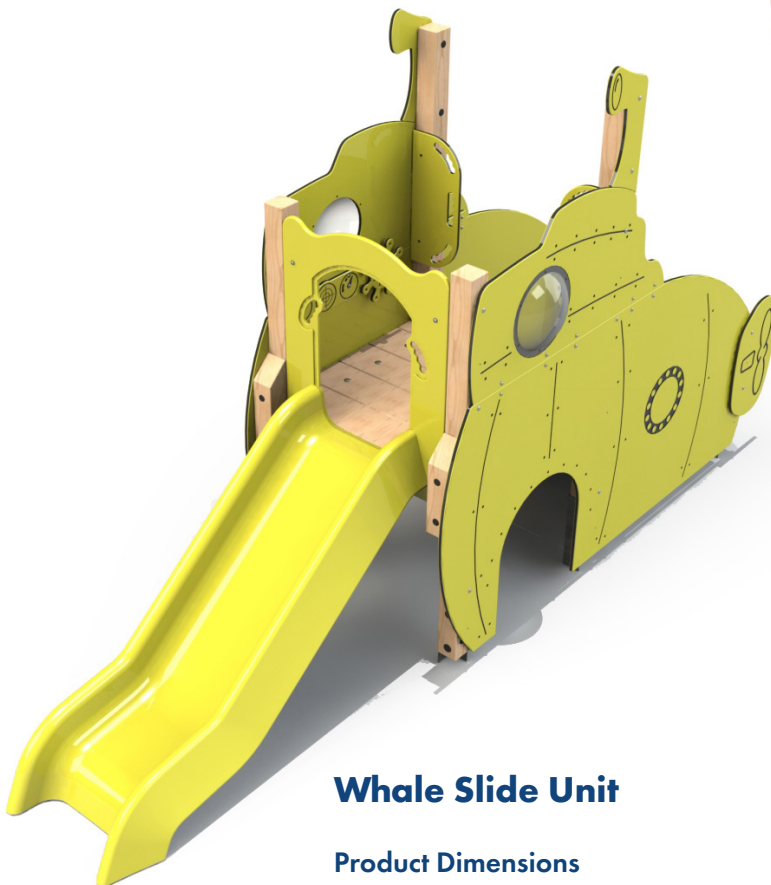

## Whale Slide Unit

### Product Dimensions

3970mm (L) 1180mm (W) 2270mm (H)

### Minimum Surface Area: 24.5m<sup>2</sup>

7160mm (L) 3990mm (W)

Free Fall Height: 900mm

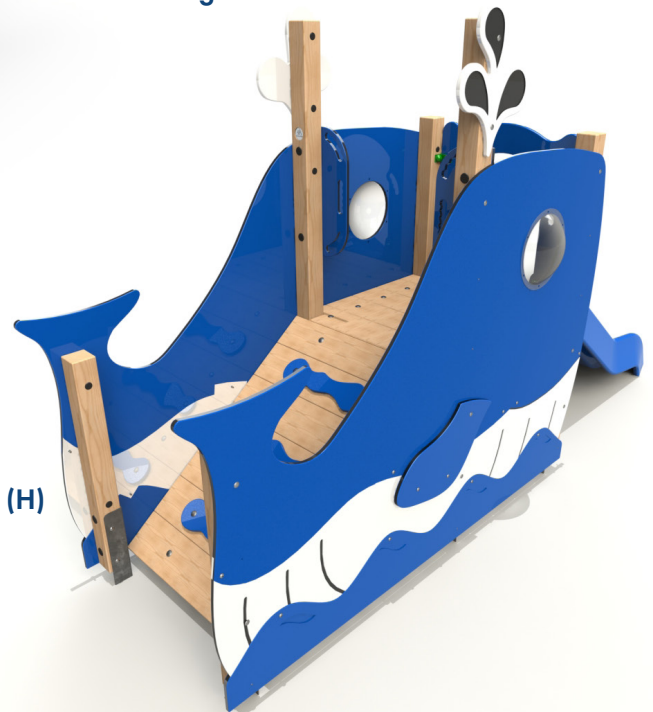

Steel feet as standard, bespoke rope colours available.





The ability to offer unrivalled value for money whilst still ensuring exceptional quality and longevity is key. The Timber Towers range accommodates all ages, budgets and play scheme sizes.

Our uncompromising approach to safety during the design and manufacturing process is paramount. With this in mind all the Timber Towers range are designed to meet the requirements of BS EN 1176.

Choose from either standard towers or create a bespoke design using the interchangeable modular play elements.

In order to ensure the highest level of accuracy, all units are produced on a custom made, state of the art, 6 Axis CNC machine. This technology allows us to offer unparalleled accuracy in the field of play timber production.

Tel: 0333 121 1121

[www.beactivegyms.co.uk](http://www.beactivegyms.co.uk)

[sales@beactivegyms.co.uk](mailto:sales@beactivegyms.co.uk)

15 Gate Lodge Close, Round Spinney Industrial Estate, Northampton NN3 8RJ